

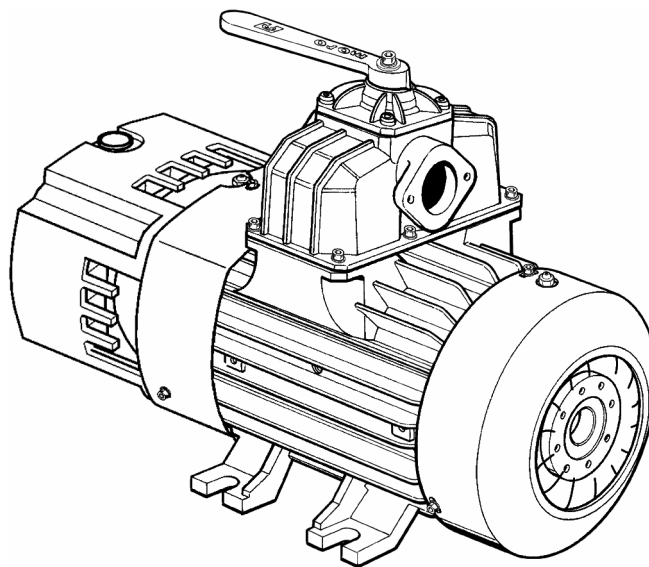

FARID INDUSTRIE S.P.A.
Divisione **MORO**
Via Pontebbana, 16
I-33080 Fiume Veneto (PN)
☎ 0039 (0) 434 951211
📠 0039 (0) 434 959066



Pompe per vuoto **Vacuum pumps** **Mod. TURBO PM80**

Libretto istruzioni, uso e manutenzione
Use and maintenance manual
Manuel pour le mode d'emploi et entretien
Handbuch für betrieb und wartung

EDIZIONE 04/2002

PRESENTATION

The vacuum pumps produced by **Allestitenti Pompe Moro S.p.a.** have a great tradition of reliability, long life and versatility. They are available with various flow rates, types of operation and cooling.

The principle of rotating volumetric operation with vanes ensures that high degrees of vacuum are reached and allows a vast field of application.

Industrial users of vacuum pumps require safe, constant running at a high vacuum for long periods.

To satisfy this need, **Allestitenti Pompe Moro S.p.a.** has developed a unique technology of liquid cooling even in the rotor, thus keeping lower temperatures inside the pump. This is to the advantage of the lubrication, the vanes and the seals, thus allowing use in harsher conditions.

CONTENTS

| | |
|---|----|
| Presentation | 2 |
| Introduction | 4 |
| Storage..... | 4 |
| Dimensions | 5 |
| Packing | 6 |
| Lifting..... | 6 |
| Data plate..... | 6 |
| Correct use..... | 8 |
| Installation | 8 |
| System diagram | 12 |
| Lubricants..... | 14 |
| Commissioning..... | 18 |
| Precautions during use of the pump..... | 20 |
| Pressure..... | 20 |
| Temperature..... | 20 |
| Maximum using time | 20 |
| Maintenance..... | 22 |
| Running in | 22 |
| Periodic checks | 22 |
| Flushing the inside of the pump body..... | 24 |
| Checking vane wear | 26 |
| Troubleshooting | 28 |

In order to improve the product, the manufacturer reserves the right to modify and update this publication without notice. All reproduction of this manual, even in part, is forbidden without the authorisation of the manufacturer.

PRESENTATION

Fiabilité, durée et flexibilité, telles sont par tradition les caractéristiques des pompes à vide de la Maison

Allestitenti Pompe Moro Spa. Celles-ci sont disponibles en plusieurs versions suivant la gamme de débits ou la façon de les actionner et de les refroidir. Le principe de fonctionnement volumétrique rotatif à palettes permet d'obtenir des degrés de vide élevés et d'avoir une vaste plage d'utilisation.

Dans l'industrie, les pompes à vide doivent garantir un fonctionnement sûr et constant à vide élevé pendant de longues périodes.







Pour répondre à cette exigence, **Allestitenti Pompe Moro Spa** a conçu un système unique au monde de refroidissement par du liquide également dans le rotor, pour avoir des températures plus basses à l'intérieur de la pompe. Le graissage approprié des palettes et des joints permet d'utiliser la pompe même dans des conditions particulièrement difficiles.

INDEX

| | |
|--|----|
| Présentation | 2 |
| Introduction | 4 |
| Emmagasinage | 4 |
| Dimensions | 5 |
| Emballage | 6 |
| Soulèvement | 6 |
| Plaque d'identification | 6 |
| Usage conforme | 8 |
| Installation | 8 |
| Schéma de l'installation..... | 12 |
| Lubrifiants..... | 14 |
| Mise en service | 18 |
| Précautions durant l'utilisation de la pompe | 20 |
| Pression | 20 |
| Température..... | 20 |
| Temps maximum d'utilisation | 20 |
| Entretien..... | 22 |
| Rodage..... | 22 |
| Contrôles périodiques | 22 |
| Lavage interne du corps de la pompe | 24 |
| Contrôle de l'usure des palettes | 26 |
| Mauvais fonctionnement: causes et remèdes | 29 |

Afin d'améliorer le produit, le constructeur se réserve le droit d'apporter, sans préavis, des modifications pour mettre à jour cette publication. Il est interdit de reproduire, même en partie, ce manuel sans l'autorisation du constructeur.

| DEUTSCH | ITALIANO | | | | | | | | | | | | | | | | | | | | | | | | | | | | | | | | | | | | | | | | | | | | | | | | | | | | | | | | | | | | | | | | | | | | | | | | | | | | | | | | | | | | | | | | |
|---|---|---|------------|---|----------|---|-------------|---|------------|---|-------|---|-------------|---|-------------------------------|---|--------------|---|----------------|----|---------------|----|------------------|----|---|----|-------|----|------------|----|--------------------|----|---------|----|-------------|----|------------------------|----|---------------------------------|----|-------------------------------------|----|---|----|---|---------------|---|--------------|---|------------------|---|------------|---|-------------|---|--------------|---|-----------------------------------|---|-------------|---|---------------|---|--------------------|----|--------------|----|--------------------|----|---------------------------------------|----|-----------|----|-------------|----|------------------------|----|--------------|----|----------|----|---------------------|----|------------------------------|----|-------------------------|----|--|----|
| <u>PRÄSENTATION</u> | <u>PRESENTAZIONE</u> | | | | | | | | | | | | | | | | | | | | | | | | | | | | | | | | | | | | | | | | | | | | | | | | | | | | | | | | | | | | | | | | | | | | | | | | | | | | | | | | | | | | | | | | |
| <p>Die Vakuumpumpen der Firma Allestitimenti Pompe Moro S.p.a. verfügen über eine bereits traditionelle Zuverlässigkeit, Haltbarkeit und Vielseitigkeit: sie stehen mit verschiedenen Förderleistungen, Antriebs- und Kühlsystemen zur Verfügung.</p> <p>Das Prinzip der volumetrischen rotativen Funktion mit Schaufeln sichert das Erzielen von hohen Vakkumgraden und ermöglicht einen weitgefächerten Einsatzbereich.</p> <p>Industrielle Anwender von Vakkumpumpen verlangen sicheren und konstanten Betrieb bei hohem Vakuum und während langen Zeiträumen.</p> <p>Um diesen Anforderungen entsprechen zu können, hat die Firma Allestitimenti Pompe Moro S.p.a. als weltweit einzige die Technologie der Flüssigkühlung auch des Läufers entwickelt, wodurch die Temperatur im Pumpeninnern niedrig gehalten wird, was der Schmierung, den Schaufeln und den Dichtungen zugute kommt und den Einsatz der Pumpe auch unter extremen Bedingungen ermöglicht.</p> | <p>Le pompe per vuoto della Allestitimenti Pompe Moro S.p.a. hanno una grande tradizione di affidabilità, durata e versatilità: sono infatti disponibili in varie gamme di portate e tipi di azionamento e di raffreddamento.</p> <p>Il principio di funzionamento volumetrico rotativo a palette garantisce il raggiungimento di elevati gradi di vuoto e consente un vasto campo di utilizzo.</p> <p>L'utilizzatore industriale delle pompe per vuoto richiede un funzionamento sicuro e costante ad alto vuoto e per lunghi periodi.</p> <p>Per rispondere a questa esigenza la Allestitimenti Pompe Moro S.p.a. ha sviluppato, unica al mondo, la tecnologia di raffreddamento a liquido anche nel rotore mantenendo così temperature più basse all'interno della pompa con beneficio della lubrificazione, delle pale e delle tenute, permettendo così utilizzi più gravosi.</p> | | | | | | | | | | | | | | | | | | | | | | | | | | | | | | | | | | | | | | | | | | | | | | | | | | | | | | | | | | | | | | | | | | | | | | | | | | | | | | | | | | | | | | | | |
| <u>INHALTSVERZEICHNIS</u> | <u>INDICE</u> | | | | | | | | | | | | | | | | | | | | | | | | | | | | | | | | | | | | | | | | | | | | | | | | | | | | | | | | | | | | | | | | | | | | | | | | | | | | | | | | | | | | | | | | |
| <table> <tr><td>Präsentation</td><td style="text-align: right;">3</td></tr> <tr><td>Einführung</td><td style="text-align: right;">4</td></tr> <tr><td>Lagerung</td><td style="text-align: right;">4</td></tr> <tr><td>Abmessungen</td><td style="text-align: right;">5</td></tr> <tr><td>Verpackung</td><td style="text-align: right;">6</td></tr> <tr><td>Heben</td><td style="text-align: right;">6</td></tr> <tr><td>Typenschild</td><td style="text-align: right;">6</td></tr> <tr><td>Eigentlicher Verwendungszweck</td><td style="text-align: right;">8</td></tr> <tr><td>Installation</td><td style="text-align: right;">8</td></tr> <tr><td>Anlagen-Schema</td><td style="text-align: right;">12</td></tr> <tr><td>Schmiermittel</td><td style="text-align: right;">14</td></tr> <tr><td>Inbetriebsetzung</td><td style="text-align: right;">18</td></tr> <tr><td>Vorsichtsmaßnahmen während dem Gebrauch der Pumpe</td><td style="text-align: right;">20</td></tr> <tr><td>Druck</td><td style="text-align: right;">20</td></tr> <tr><td>Temperatur</td><td style="text-align: right;">20</td></tr> <tr><td>Höchstbetriebszeit</td><td style="text-align: right;">20</td></tr> <tr><td>Wartung</td><td style="text-align: right;">22</td></tr> <tr><td>Einlaufzeit</td><td style="text-align: right;">22</td></tr> <tr><td>Regelmäßige Kontrollen</td><td style="text-align: right;">22</td></tr> <tr><td>Innere Wäsche des Pumpenkörpers</td><td style="text-align: right;">24</td></tr> <tr><td>Kontrolle des Schaufelverschleisses</td><td style="text-align: right;">26</td></tr> <tr><td>Funktionsstörungen: Ursachen und Abhilfen</td><td style="text-align: right;">30</td></tr> </table> | Präsentation | 3 | Einführung | 4 | Lagerung | 4 | Abmessungen | 5 | Verpackung | 6 | Heben | 6 | Typenschild | 6 | Eigentlicher Verwendungszweck | 8 | Installation | 8 | Anlagen-Schema | 12 | Schmiermittel | 14 | Inbetriebsetzung | 18 | Vorsichtsmaßnahmen während dem Gebrauch der Pumpe | 20 | Druck | 20 | Temperatur | 20 | Höchstbetriebszeit | 20 | Wartung | 22 | Einlaufzeit | 22 | Regelmäßige Kontrollen | 22 | Innere Wäsche des Pumpenkörpers | 24 | Kontrolle des Schaufelverschleisses | 26 | Funktionsstörungen: Ursachen und Abhilfen | 30 | <table> <tr><td>Presentazione</td><td style="text-align: right;">3</td></tr> <tr><td>Introduzione</td><td style="text-align: right;">5</td></tr> <tr><td>Immagazzinamento</td><td style="text-align: right;">5</td></tr> <tr><td>Dimensioni</td><td style="text-align: right;">5</td></tr> <tr><td>Imballaggio</td><td style="text-align: right;">7</td></tr> <tr><td>Sollewamento</td><td style="text-align: right;">7</td></tr> <tr><td>Targhetta di identificazione dati</td><td style="text-align: right;">7</td></tr> <tr><td>Uso Proprio</td><td style="text-align: right;">9</td></tr> <tr><td>Installazione</td><td style="text-align: right;">9</td></tr> <tr><td>Schema di impianto</td><td style="text-align: right;">13</td></tr> <tr><td>Lubrificanti</td><td style="text-align: right;">15</td></tr> <tr><td>Messa in esercizio</td><td style="text-align: right;">19</td></tr> <tr><td>Precauzioni durante l'uso della pompa</td><td style="text-align: right;">21</td></tr> <tr><td>Pressione</td><td style="text-align: right;">21</td></tr> <tr><td>Temperatura</td><td style="text-align: right;">21</td></tr> <tr><td>Tempo massimo utilizzo</td><td style="text-align: right;">21</td></tr> <tr><td>Manutenzione</td><td style="text-align: right;">23</td></tr> <tr><td>Rodaggio</td><td style="text-align: right;">23</td></tr> <tr><td>Controlli periodici</td><td style="text-align: right;">23</td></tr> <tr><td>Lavaggio interno corpo pompa</td><td style="text-align: right;">25</td></tr> <tr><td>Controllo usura palette</td><td style="text-align: right;">27</td></tr> <tr><td>Cause e rimedi di un cattivo funzionamento</td><td style="text-align: right;">31</td></tr> </table> | Presentazione | 3 | Introduzione | 5 | Immagazzinamento | 5 | Dimensioni | 5 | Imballaggio | 7 | Sollewamento | 7 | Targhetta di identificazione dati | 7 | Uso Proprio | 9 | Installazione | 9 | Schema di impianto | 13 | Lubrificanti | 15 | Messa in esercizio | 19 | Precauzioni durante l'uso della pompa | 21 | Pressione | 21 | Temperatura | 21 | Tempo massimo utilizzo | 21 | Manutenzione | 23 | Rodaggio | 23 | Controlli periodici | 23 | Lavaggio interno corpo pompa | 25 | Controllo usura palette | 27 | Cause e rimedi di un cattivo funzionamento | 31 |
| Präsentation | 3 | | | | | | | | | | | | | | | | | | | | | | | | | | | | | | | | | | | | | | | | | | | | | | | | | | | | | | | | | | | | | | | | | | | | | | | | | | | | | | | | | | | | | | | | |
| Einführung | 4 | | | | | | | | | | | | | | | | | | | | | | | | | | | | | | | | | | | | | | | | | | | | | | | | | | | | | | | | | | | | | | | | | | | | | | | | | | | | | | | | | | | | | | | | |
| Lagerung | 4 | | | | | | | | | | | | | | | | | | | | | | | | | | | | | | | | | | | | | | | | | | | | | | | | | | | | | | | | | | | | | | | | | | | | | | | | | | | | | | | | | | | | | | | | |
| Abmessungen | 5 | | | | | | | | | | | | | | | | | | | | | | | | | | | | | | | | | | | | | | | | | | | | | | | | | | | | | | | | | | | | | | | | | | | | | | | | | | | | | | | | | | | | | | | | |
| Verpackung | 6 | | | | | | | | | | | | | | | | | | | | | | | | | | | | | | | | | | | | | | | | | | | | | | | | | | | | | | | | | | | | | | | | | | | | | | | | | | | | | | | | | | | | | | | | |
| Heben | 6 | | | | | | | | | | | | | | | | | | | | | | | | | | | | | | | | | | | | | | | | | | | | | | | | | | | | | | | | | | | | | | | | | | | | | | | | | | | | | | | | | | | | | | | | |
| Typenschild | 6 | | | | | | | | | | | | | | | | | | | | | | | | | | | | | | | | | | | | | | | | | | | | | | | | | | | | | | | | | | | | | | | | | | | | | | | | | | | | | | | | | | | | | | | | |
| Eigentlicher Verwendungszweck | 8 | | | | | | | | | | | | | | | | | | | | | | | | | | | | | | | | | | | | | | | | | | | | | | | | | | | | | | | | | | | | | | | | | | | | | | | | | | | | | | | | | | | | | | | | |
| Installation | 8 | | | | | | | | | | | | | | | | | | | | | | | | | | | | | | | | | | | | | | | | | | | | | | | | | | | | | | | | | | | | | | | | | | | | | | | | | | | | | | | | | | | | | | | | |
| Anlagen-Schema | 12 | | | | | | | | | | | | | | | | | | | | | | | | | | | | | | | | | | | | | | | | | | | | | | | | | | | | | | | | | | | | | | | | | | | | | | | | | | | | | | | | | | | | | | | | |
| Schmiermittel | 14 | | | | | | | | | | | | | | | | | | | | | | | | | | | | | | | | | | | | | | | | | | | | | | | | | | | | | | | | | | | | | | | | | | | | | | | | | | | | | | | | | | | | | | | | |
| Inbetriebsetzung | 18 | | | | | | | | | | | | | | | | | | | | | | | | | | | | | | | | | | | | | | | | | | | | | | | | | | | | | | | | | | | | | | | | | | | | | | | | | | | | | | | | | | | | | | | | |
| Vorsichtsmaßnahmen während dem Gebrauch der Pumpe | 20 | | | | | | | | | | | | | | | | | | | | | | | | | | | | | | | | | | | | | | | | | | | | | | | | | | | | | | | | | | | | | | | | | | | | | | | | | | | | | | | | | | | | | | | | |
| Druck | 20 | | | | | | | | | | | | | | | | | | | | | | | | | | | | | | | | | | | | | | | | | | | | | | | | | | | | | | | | | | | | | | | | | | | | | | | | | | | | | | | | | | | | | | | | |
| Temperatur | 20 | | | | | | | | | | | | | | | | | | | | | | | | | | | | | | | | | | | | | | | | | | | | | | | | | | | | | | | | | | | | | | | | | | | | | | | | | | | | | | | | | | | | | | | | |
| Höchstbetriebszeit | 20 | | | | | | | | | | | | | | | | | | | | | | | | | | | | | | | | | | | | | | | | | | | | | | | | | | | | | | | | | | | | | | | | | | | | | | | | | | | | | | | | | | | | | | | | |
| Wartung | 22 | | | | | | | | | | | | | | | | | | | | | | | | | | | | | | | | | | | | | | | | | | | | | | | | | | | | | | | | | | | | | | | | | | | | | | | | | | | | | | | | | | | | | | | | |
| Einlaufzeit | 22 | | | | | | | | | | | | | | | | | | | | | | | | | | | | | | | | | | | | | | | | | | | | | | | | | | | | | | | | | | | | | | | | | | | | | | | | | | | | | | | | | | | | | | | | |
| Regelmäßige Kontrollen | 22 | | | | | | | | | | | | | | | | | | | | | | | | | | | | | | | | | | | | | | | | | | | | | | | | | | | | | | | | | | | | | | | | | | | | | | | | | | | | | | | | | | | | | | | | |
| Innere Wäsche des Pumpenkörpers | 24 | | | | | | | | | | | | | | | | | | | | | | | | | | | | | | | | | | | | | | | | | | | | | | | | | | | | | | | | | | | | | | | | | | | | | | | | | | | | | | | | | | | | | | | | |
| Kontrolle des Schaufelverschleisses | 26 | | | | | | | | | | | | | | | | | | | | | | | | | | | | | | | | | | | | | | | | | | | | | | | | | | | | | | | | | | | | | | | | | | | | | | | | | | | | | | | | | | | | | | | | |
| Funktionsstörungen: Ursachen und Abhilfen | 30 | | | | | | | | | | | | | | | | | | | | | | | | | | | | | | | | | | | | | | | | | | | | | | | | | | | | | | | | | | | | | | | | | | | | | | | | | | | | | | | | | | | | | | | | |
| Presentazione | 3 | | | | | | | | | | | | | | | | | | | | | | | | | | | | | | | | | | | | | | | | | | | | | | | | | | | | | | | | | | | | | | | | | | | | | | | | | | | | | | | | | | | | | | | | |
| Introduzione | 5 | | | | | | | | | | | | | | | | | | | | | | | | | | | | | | | | | | | | | | | | | | | | | | | | | | | | | | | | | | | | | | | | | | | | | | | | | | | | | | | | | | | | | | | | |
| Immagazzinamento | 5 | | | | | | | | | | | | | | | | | | | | | | | | | | | | | | | | | | | | | | | | | | | | | | | | | | | | | | | | | | | | | | | | | | | | | | | | | | | | | | | | | | | | | | | | |
| Dimensioni | 5 | | | | | | | | | | | | | | | | | | | | | | | | | | | | | | | | | | | | | | | | | | | | | | | | | | | | | | | | | | | | | | | | | | | | | | | | | | | | | | | | | | | | | | | | |
| Imballaggio | 7 | | | | | | | | | | | | | | | | | | | | | | | | | | | | | | | | | | | | | | | | | | | | | | | | | | | | | | | | | | | | | | | | | | | | | | | | | | | | | | | | | | | | | | | | |
| Sollewamento | 7 | | | | | | | | | | | | | | | | | | | | | | | | | | | | | | | | | | | | | | | | | | | | | | | | | | | | | | | | | | | | | | | | | | | | | | | | | | | | | | | | | | | | | | | | |
| Targhetta di identificazione dati | 7 | | | | | | | | | | | | | | | | | | | | | | | | | | | | | | | | | | | | | | | | | | | | | | | | | | | | | | | | | | | | | | | | | | | | | | | | | | | | | | | | | | | | | | | | |
| Uso Proprio | 9 | | | | | | | | | | | | | | | | | | | | | | | | | | | | | | | | | | | | | | | | | | | | | | | | | | | | | | | | | | | | | | | | | | | | | | | | | | | | | | | | | | | | | | | | |
| Installazione | 9 | | | | | | | | | | | | | | | | | | | | | | | | | | | | | | | | | | | | | | | | | | | | | | | | | | | | | | | | | | | | | | | | | | | | | | | | | | | | | | | | | | | | | | | | |
| Schema di impianto | 13 | | | | | | | | | | | | | | | | | | | | | | | | | | | | | | | | | | | | | | | | | | | | | | | | | | | | | | | | | | | | | | | | | | | | | | | | | | | | | | | | | | | | | | | | |
| Lubrificanti | 15 | | | | | | | | | | | | | | | | | | | | | | | | | | | | | | | | | | | | | | | | | | | | | | | | | | | | | | | | | | | | | | | | | | | | | | | | | | | | | | | | | | | | | | | | |
| Messa in esercizio | 19 | | | | | | | | | | | | | | | | | | | | | | | | | | | | | | | | | | | | | | | | | | | | | | | | | | | | | | | | | | | | | | | | | | | | | | | | | | | | | | | | | | | | | | | | |
| Precauzioni durante l'uso della pompa | 21 | | | | | | | | | | | | | | | | | | | | | | | | | | | | | | | | | | | | | | | | | | | | | | | | | | | | | | | | | | | | | | | | | | | | | | | | | | | | | | | | | | | | | | | | |
| Pressione | 21 | | | | | | | | | | | | | | | | | | | | | | | | | | | | | | | | | | | | | | | | | | | | | | | | | | | | | | | | | | | | | | | | | | | | | | | | | | | | | | | | | | | | | | | | |
| Temperatura | 21 | | | | | | | | | | | | | | | | | | | | | | | | | | | | | | | | | | | | | | | | | | | | | | | | | | | | | | | | | | | | | | | | | | | | | | | | | | | | | | | | | | | | | | | | |
| Tempo massimo utilizzo | 21 | | | | | | | | | | | | | | | | | | | | | | | | | | | | | | | | | | | | | | | | | | | | | | | | | | | | | | | | | | | | | | | | | | | | | | | | | | | | | | | | | | | | | | | | |
| Manutenzione | 23 | | | | | | | | | | | | | | | | | | | | | | | | | | | | | | | | | | | | | | | | | | | | | | | | | | | | | | | | | | | | | | | | | | | | | | | | | | | | | | | | | | | | | | | | |
| Rodaggio | 23 | | | | | | | | | | | | | | | | | | | | | | | | | | | | | | | | | | | | | | | | | | | | | | | | | | | | | | | | | | | | | | | | | | | | | | | | | | | | | | | | | | | | | | | | |
| Controlli periodici | 23 | | | | | | | | | | | | | | | | | | | | | | | | | | | | | | | | | | | | | | | | | | | | | | | | | | | | | | | | | | | | | | | | | | | | | | | | | | | | | | | | | | | | | | | | |
| Lavaggio interno corpo pompa | 25 | | | | | | | | | | | | | | | | | | | | | | | | | | | | | | | | | | | | | | | | | | | | | | | | | | | | | | | | | | | | | | | | | | | | | | | | | | | | | | | | | | | | | | | | |
| Controllo usura palette | 27 | | | | | | | | | | | | | | | | | | | | | | | | | | | | | | | | | | | | | | | | | | | | | | | | | | | | | | | | | | | | | | | | | | | | | | | | | | | | | | | | | | | | | | | | |
| Cause e rimedi di un cattivo funzionamento | 31 | | | | | | | | | | | | | | | | | | | | | | | | | | | | | | | | | | | | | | | | | | | | | | | | | | | | | | | | | | | | | | | | | | | | | | | | | | | | | | | | | | | | | | | | |
| <p>Der Hersteller behält sich das Recht vor, zum Zwecke der Verbesserung des Produktes Änderungen für die Aktualisierung dieser Veröffentlichung ohne Vorankündigung durchzuführen. Der Nachdruck dieser Betriebsanleitung, auch auszugsweise, ohne Genehmigung des Herstellers ist verboten.</p> | <p>Il costruttore si riserva allo scopo di migliorare il prodotto, il diritto di apportare modifiche per l'aggiornamento di questa pubblicazione senza preavviso. E' inoltre vietata qualsiasi riproduzione, anche parziale del presente libretto, senza l'autorizzazione del costruttore.</p> | | | | | | | | | | | | | | | | | | | | | | | | | | | | | | | | | | | | | | | | | | | | | | | | | | | | | | | | | | | | | | | | | | | | | | | | | | | | | | | | | | | | | | | | |

| ENGLISH | FRANÇAIS | DEUTSCH |
|--|---|---|
| <p align="center">INTRODUCTION</p> <p>For good operation of the vacuum pump, carefully read these instructions for use.</p> <p>This manual can help you solve all the problems that arise during assembly and use of the vacuum pump. We recommend that you always keep the manual in the vicinity of the vacuum pump.</p> <p>This manual is an integral part of the product.</p> <p>KEEP THIS MANUAL WITH CARE FOR FUTURE CONSULTATION.</p> <p> The user of the vacuum pump must be informed of the contents of this manual.</p> <p> The manufacturer cannot be held responsible for any damage due to incorrect, erroneous or unreasonable use.</p> <p align="center">STORAGE</p> <p>To keep the vacuum pump correctly, it must be stored as follows:</p> <ul style="list-style-type: none"> - indoors, sheltered from external atmospheric agents; - in a horizontal position, standing on its four feet. <p>During inspection, the vacuum pumps are lubricated in our factory with a particular oil which guarantees conservation of the various internal components for about 6 months.</p> <p>In the event of prolonged storage, we advise flushing the inside of the pump with Diesel fuel and oil (see page 25), checking and, if necessary, changing the gaskets.</p> <p>PERFORMANCE</p> <ol style="list-style-type: none"> 1 - Rotation speed (direct coupling) 2 - Flow rate with free suction 3 - Flow rate with suction in 50% vacuum 4 - Nominal vacuum 5 - Maximum vacuum 6 - Nominal pressure 7 - Max. overpressure in compressor operation 8 - Power requirement at 2 barg 9 - Power requirement at nominal vacuum 10 - Power requirement in 50% vacuum 11 - Oil consumption 12 - Oil tank capacity 13 - Intermission to top up with oil. 14 - Weight <p>15 - MAXIMUM USING TIME (MINUTES) See table pag.21</p> <p>IMPORTANT: the times indicated refer to normal working conditions with intermittent duty. For harsh conditions or for continuous duty, contact an Allestimenti Pompe Moro S.p.A. authorized dealer.</p> | <p align="center">INTRODUCTION</p> <p>Pour le bon fonctionnement de la pompe à vide, lire attentivement les indications. Ce manuel vous aidera à résoudre tous les problèmes qui se présentent au moment du montage et en cours d'utilisation de la pompe à vide.</p> <p>Nous vous conseillons de conserver ce manuel à proximité de la pompe. Le présent manuel est partie intégrante du produit.</p> <p>CONSERVER SOIGNEUSEMENT CE MANUEL POUR POUVOIR LE CONSULTER EN CAS DE BESOIN.</p> <p> L'utilisateur de la pompe à vide doit connaître le contenu du présent manuel.</p> <p> Le constructeur décline toute responsabilité pour des dommages éventuels causés par un usage impropre ou inadéquat.</p> <p align="center">EMMAGASINAGE</p> <p>Pour bien conserver la pompe à vide, il faut l'emmagasiner:</p> <ul style="list-style-type: none"> - dans un endroit couvert, à l'abri des agents atmosphériques; - en position horizontale et posée sur les quatre pieds. <p>Les pompes à vide sont graissées en usine en phase d'essai avec une huile spéciale qui garantit la conservation des différents composants internes pendant environ 6 mois.</p> <p>En cas d'emmagasinage prolongé, il est conseillé de laver l'intérieur du corps de la pompe avec du mazout et de l'huile (voir page 25), de contrôler et de changer les joints si nécessaire.</p> <p>PERFORMANCES</p> <ol style="list-style-type: none"> 1 - Vitesse de rotation (prise directe) 2 - Débit en aspiration libre 3 - Débit en aspiration avec 50% de vide 4 - Vide nominal 5 - Vide maximum 6 - Pression nominal 7 - Pression maximum 8 - Puissance absorbée au 2 barg 9 - Puissance absorbée au vide nominal 10 - Puissance absorbée au 50% vide 11 - Consommation d'huile 12 - Capacité du réservoir d'huile 13 - Intervalle pour le remplissage de l'huile. 14 - Poids <p>15 - TEMPS MAXIMUM D'UTILISATION (MINUTES) Voir tableau page 21</p> <p>IMPORTANT: les temps indiqués se réfèrent à des conditions normales de fonctionnement et à une utilisation discontinue. Pour des conditions difficiles et une utilisation continue, contacter un Allestimenti Pompe Moro S.p.A. revendeur agréé.</p> | <p align="center">EINFÜHRUNG</p> <p>Für die einwandfreie Funktion der Vakuumpumpe sollte die vorliegende Betriebsanleitung unbedingt sorgfältig durchgelesen werden. Dieses Heft kann Ihnen bei der Lösung von eventuell bei der Montage oder dem Einsatz der Vakuumpumpe auftretenden Problemen behilflich sein. Es empfiehlt sich, das Heft stets griffbereit in der Nähe der Vakuumpumpe zu verwahren.</p> <p>Die vorliegende Betriebsanleitung ist wesentlicher Teil des Produktes.</p> <p>BEWAHREN SIE DIESES HEFT FÜR ZUKÜNFTIGES NA-CHSCHLAGEN SORGFÄLTIG AUF.</p> <p> Der Benutzer der Vakuumpumpe muß über den Inhalt dieses Heftes in Kenntnis gesetzt werden.</p> <p> Der Hersteller haftet nicht für eventuelle Schäden, die durch die ungeeignete, falsche oder unvernünftige Verwendung der Vakuumpumpe entstehen.</p> <p align="center">LAGERUNG</p> <p>Für ihre korrekte Konservierung muß die Vakuumpumpe wie folgt eingelagert werden:</p> <ul style="list-style-type: none"> - in einem geschlossenen, vor Witterungseinflüssen geschützten Raum; - waagrecht auf vier Füßen aufgelegt. Die Vakuumpumpen werden während der Abnahmeprüfung in unserem Werk mit einem Spezialöl geschmiert, welches die Konservierung der inneren Komponenten für die Dauer von zirka 6 Monaten garantiert. <p>Im Falle des längeren Einlagerns empfiehlt es sich das Innere des Pumpenkörpers mit Naphta oder Öl (siehe Seite 25) zu waschen und die Dichtungselemente zu kontrollieren und eventuell zu ersetzen.</p> <p>LEISTUNGSDATEN</p> <ol style="list-style-type: none"> 1 - Drehgeschwindigkeit (Direk-tantrieb) 2 - Förderleistung bei freier Saugung 3 - Saugfördermenge bei 50% Vakuum 4 - Nennvakuum 5 - Max. Vakuum 6 - Betriebsüberdruck 7 - Höchstdruck 8 - Leistungsbedarf an der Welle bei 2 bar Überdruck 9 - Stromaufnahme bei Betriebsüberdruck. 10 - Stromaufnahme bei 50% Vakuum 11 - Ölverbrauch 12 - Fassungsvermögen Öltank 13 - Intervall für Öl nachfüllung. 14 - Gewicht <p>15 - HÖCHSTBETRIEBSZEIT (MINUTEN): Siehe Tab. 5 Seite 21</p> <p>WICHTIG: die angegebenen Zeiträume beziehen sich auf normale Betriebsbedingungen bei diskontinuierlichem Einsatz. Für besonders belastende Betriebsbedingungen oder Dauereinsatz wenden Sie sich bitte an einen von der Firma Allestimenti Pompe Moro S.p.A. autorisierten Händler.</p> |

INTRODUZIONE

Per il buon funzionamento della pompa per vuoto leggere attentamente queste prescrizioni di esercizio. Questo libretto può aiutarVi a risolvere tutti i problemi che si pongono all'atto del montaggio e nell'uso della pompa per vuoto.

Vi consigliamo di tenere sempre questo libretto nelle vicinanze della pompa per vuoto.

Il presente libretto costituisce parte integrante del prodotto.

CONSERVARE CON CURA QUESTO LIBRETTO PER OGNI ULTERIORE CONSULTAZIONE.



Il contenuto del presente libretto deve essere portato a conoscenza dell'utilizzatore della pompa per vuoto.



Il costruttore non può essere considerato responsabile per eventuali danni derivati da usi impropri, erronei ed irragionevoli.

IMMAGAZZINAMENTO

Per una corretta conservazione della pompa per vuoto, essa deve essere immagazzinata:

- al coperto, al riparo di agenti atmosferici esterni;
- in posizione orizzontale appoggiata sui quattro piedi.









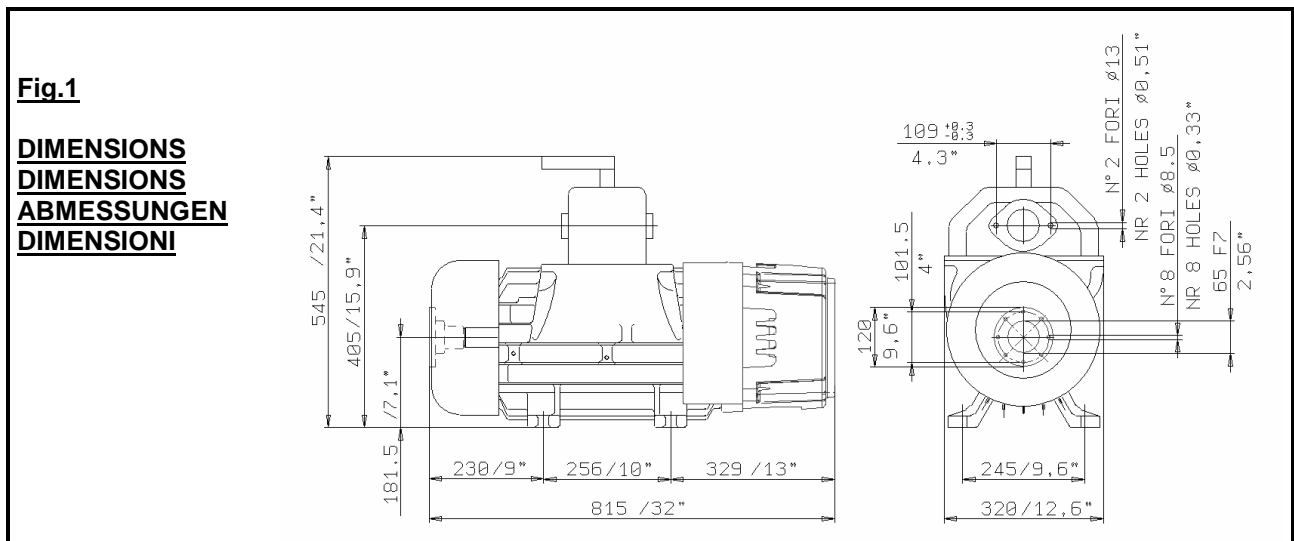



Le pompe per vuoto vengono lubrificate, in fase di collaudo, presso in nostro stabilimento, con un particolare olio che ne garantisce la conservazione dei vari componenti interni per circa 6 mesi.

In caso di immagazzinamento prolungato si consiglia il lavaggio interno del corpo con nafta e olio (vedi pag. 25) e il controllo, ed eventuale sostituzione degli elementi di guarnizione.

| PRESTAZIONI | [u.m.] | TURBO PM80 |
|---|---------------------------|----------------|
| 1 - Velocità di rotazione (presa diretta) | rpm | 1100 |
| 2 - Portata in aspirazione libera | m ³ /h / (cfm) | 595 / (350) |
| 3 - Portata a 15" hg (50% di vuoto) | m ³ /h / (cfm) | 459 / (270) |
| 4 - Vuoto nominale | % | 80 |
| 5 - Vuoto massimo | % | 95 |
| 6 - Pressione nominale | barg / (psig) | 0,5 / (7,25) |
| 7 - Pressione massima | barg / (psig) | 2 / (29) |
| 8 - Potenza richiesta a 2 barg | kW/HP | 26 / 35 |
| 9 - Potenza richiesta al vuoto nominale | kW /HP | 10,4 / 14,1 |
| 10 - Potenza richiesta a 15"hg (50% di vuoto) | kW/HP | 8 / 11 |
| 11 - Consumo di olio | l/h (gal(US)/h) | 0,24 / (0,063) |
| 12 - Capacità del serbatoio | l/(gal(US)) | 4,5 / (1,2) |
| 13 - Intervallo per il rabbocco dell'olio | h | 16 |
| 14 - Peso | kg/ (lb) | 182 / (401) |
| 15 - Tempo massimo di utilizzo | min | 20 ogni ora |

IMPORTANTE: i tempi indicati sono per condizioni normali di funzionamento a impiego discontinuo. Per impieghi gravosi o per uso continuo contattare un rivenditore autorizzato dalla **Allestimenti Pompe Moro S.p.A.**



| ENGLISH | FRANÇAIS | DEUTSCH |
|---|---|--|
| <p style="text-align: center;"><u>PACKING</u></p> <p>The vacuum pump is supplied without packing. Special packing may be supplied on request, such as:</p> <ul style="list-style-type: none"> - cardboard box; - wooden bed and shrink-wrap for single packages; - wooden pallet and shrink-wrap; - wooden crates and shrink-wrap. <p>The packing components (bags, boxes, nails, etc.) must not be left within reach of children as they are potential sources of danger.</p> <p style="text-align: center;"><u>LIFTING (Fig.1a)</u></p> <p>The vacuum pump must be fitted only with a pair of straps. WEIGHT: See table on page 5.</p> <p> ATTENTION: Do not damage the pipes and oilers when lifting.</p> <p>GENERAL PRECAUTIONS</p> <p> The warnings marked with this symbol indicate danger to personal safety.</p> <p>To guarantee maximum safety at work, we recommend taking the maximum care in the operations for which the description is marked with this symbol. This must be brought to the attention of all operators working with the vacuum pump.</p> <p>The vacuum pump must not be used by children, adolescents or persons who are incapable (under the influence of alcohol).</p> <p> The warnings marked with this symbol indicate danger to environmental safety.</p> <p style="text-align: center;"><u>DATA PLATE</u></p> <p>The data plate showing the main technical characteristics is located on the vacuum pump and is always visible.</p> <p> When purchasing the product, ensure that it has a plate. If not, immediately notify the manufacturer and/or the dealer. Appliances without a plate must not be used, otherwise the manufacturer declines all responsibility. Products without a plate must be considered anonymous and potentially dangerous.</p> <ul style="list-style-type: none"> 1 - Manufacturer 2 - "CE" mark 3 - Model 4 - Model code number 5 - Pump serial number 6 - Max. absorbed power 7 - Max. rotation speed (rpm) 8 - Year of manufacture | <p style="text-align: center;"><u>EMBALLAGE</u></p> <p>La pompe à vide est livrée non emballée. Sur demande, on peut effectuer des emballages spéciaux tels que:</p> <ul style="list-style-type: none"> - carton, - plateau en bois et thermorétractible pour emballages individuels, - palette en bois et thermorétractible, - caisse en bois et thermorétractible. <p>Tenir les éléments de l'emballage (sachets, boîtes, clous, etc.) hors de portée des enfants car ils peuvent être dangereux.</p> <p style="text-align: center;"><u>SOULEVEMENT (Fig.1a)</u></p> <p>Utiliser deux courroies pour soulever la pompe à vide. POIDS: Voir "tableau" page 5.</p> <p> ATTENTION: Durant le soulèvement, ne pas abîmer les tubes et les graisseurs.</p> <p> PRECAUTIONS GENERALES</p> <p>Ce symbole indique un risque pour la sécurité des personnes.</p> <p>Pour garantir le maximum de sécurité durant le travail, se conformer strictement aux indications reportant ce symbole. Tous les opérateurs qui travaillent avec la pompe à vide doivent en être informés.</p> <p>Les enfants, les adolescents ou les personnes incapables (par ex. en état d'ivresse) ne doivent pas utiliser la pompe à vide.</p> <p> Ce symbole indique un risque pour la sécurité de l'environnement.</p> <p style="text-align: center;"><u>PLAQUE D'IDENTIFICATION</u></p> <p>La plaque d'identification qui contient les principales données techniques est placée de façon bien visible sur la pompe à vide.</p> <p> A l'achat, contrôler que le produit ait bien la plaque correspondante. Sinon, contacter immédiatement le constructeur et/ ou le revendeur. Le constructeur décline toute responsabilité en cas d'utilisation d'appareils démunis de plaque qui doivent être considérés anonymes et potentiellement dangereux.</p> <ul style="list-style-type: none"> 1 - Constructeur 2 - Label "CE" 3 - Modèle 4 - N° de code du modèle 5 - N° de série 6 - Puissance max. absorbée 7 - Vitesse de rotation max. (tours / min.) 8 - Année de construction | <p style="text-align: center;"><u>VERPACKUNG</u></p> <p>Die Vakuumpumpe wird unverpackt geliefert. Auf Anfrage stehen jedoch die folgenden Verpackungen zur Verfügung:</p> <ul style="list-style-type: none"> - Karton; - Holzplatte und Schrumpffolie für Einzelverpackungen; - Holzpalette und Schrumpffolie; - Holzkisten und Schrumpffolie. <p>Die Verpackungsteile (Beutel, Kartons, Nägel, usw.) sind potentielle Gefahrenquellen und dürfen als solche nicht in die Hände von Kindern gelangen.</p> <p style="text-align: center;"><u>HEBEN (Abb.1a)</u></p> <p>Die Vakuumpumpe darf ausschließlich mit einem Paar Riemen gehoben werden. GEWICHT: siehe "Tabelle", Seite 5.</p> <p> ACHTUNG: während dem Heben darauf achten, daß die Schläuche und Öler nicht beschädigt werden.</p> <p> ALLGEMEINE VORSICHTSMASSNAHMEN</p> <p>Die mit diesem Symbol bezeichneten Hinweise weisen auf eine Gefahr für die Sicherheit von Personen hin. Um während der Arbeit die größtmögliche Sicherheit zu garantieren, muß bei der Ausführung der mit diesem Symbol bezeichneten Operationen mit größter Vorsicht vorgegangen werden. Die beschriebenen Vorsichtsmaßnahmen müssen allen mit der Vakuumpumpe arbeitenden Mitarbeitern bekannt sein. Die Vakuumpumpe darf nicht von Kindern, Minderjährigen oder unfähigen Personen (Trunkenheit) verwendet werden.</p> <p> Die mit diesem Symbol bezeichneten Hinweise stehen für Gefahren für die Umwelt.</p> <p style="text-align: center;"><u>TYPENSCHILD</u></p> <p>Das die wichtigsten technischen Merkmale beschreibende Typenschild ist an einer in jeder Situation gut sichtbaren Stelle an der Vakuumpumpe angebracht.</p> <p> Stellen Sie im Augenblick des Erwerbs sicher, daß das Produkt mit einem Typenschild ausgestattet ist. Im gegenteiligen Fall sofort den Hersteller und/oder den Händler benachrichtigen. Geräte ohne Typenschild dürfen nicht eingesetzt werden, weil sonst jede Haftpflicht seitens des Herstellers verfällt. Nicht mit diesem Typenschild ausgestattete Produkte sind als anonym und potentiell gefährlich zu erachten.</p> <ul style="list-style-type: none"> 1 - Hersteller 2 - "CE"-Kennzeichnung 3 - Modell 4 - Bestellnummer des Modells 5 - Seriennummer des Gerätes 6 - Max. Stromaufnahme 7 - Höchstgeschwindigkeit der Umdrehung (Umdrehg./ Min.) 8 - Baujahr |

IMBALLAGGIO

La pompa per vuoto viene fornita non imballata. A richiesta sono possibili imballaggi particolari, quali:

- scatola di cartone;
- pianale di legno e termoretraibile per imballaggi singoli;
- bancale di legno e termoretraibile;
- casse di legno e termoretraibile.

Gli elementi dell'imballo (sacchetti, scatole, chiodi, ecc.) non devono essere lasciati alla portata dei bambini in quanto potenziali fonti di pericolo.

SOLLEVAMENTO (vedi Fig.1a)

Sollevarre la pompa per vuoto esclusivamente con una coppia di fasce. Quando la pompa deve essere abbassata per essere appoggiata, effettuare questa manovra molto lentamente.

PESO: Vedi "tabella" pag. 5.



ATTENZIONE: Non danneggiare tubi ed oliatori durante il sollevamento.

PRECAUZIONI GENERALI

Le indicazioni contrassegnate da questo simbolo indicano **pericolo** per la sicurezza delle persone.

Per garantire la massima sicurezza durante il lavoro si richiede la massima osservanza nelle operazioni che nella descrizione vengono contrassegnate da questo simbolo, esse devono essere conosciute da tutti gli operatori che lavorano con la pompa per vuoto.

La pompa per vuoto non deve essere utilizzata da bambini, adolescenti o persone incapaci (in stato di ebbrezza).



Le indicazioni contrassegnate da questo simbolo indicano **pericolo** per la sicurezza dell'ambiente.





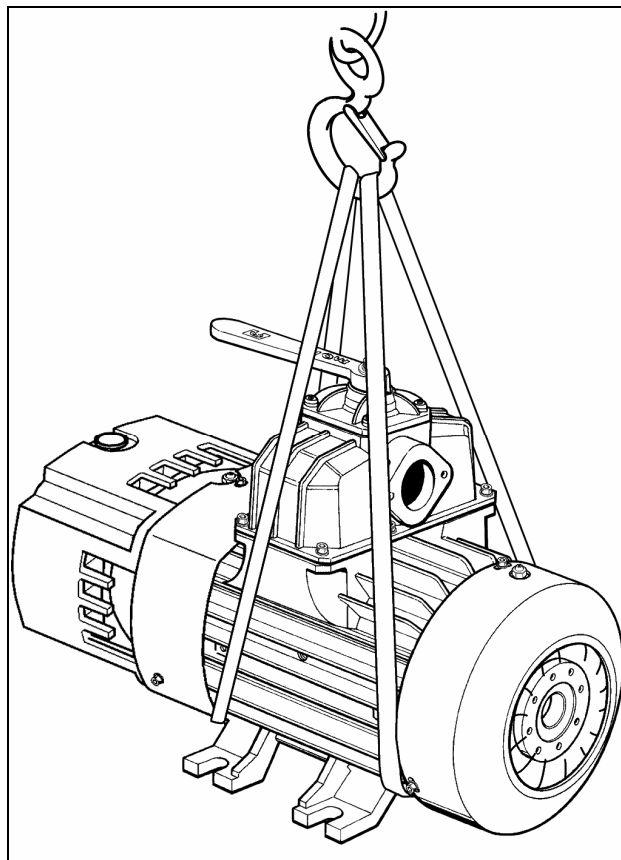
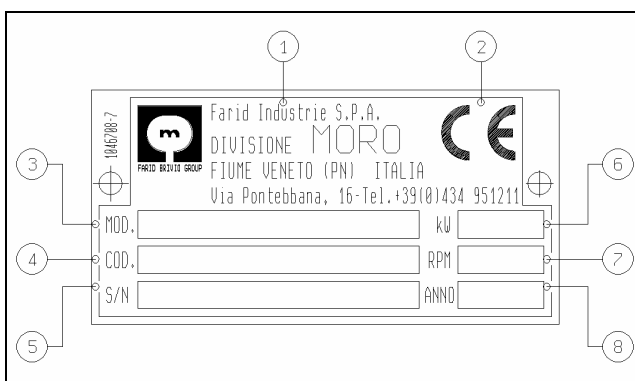

TARGHETTA DI IDENTIFICAZIONE DATI

La targhetta di identificazione con le principali caratteristiche tecniche è posizionata sulla pompa per vuoto ed è sempre visibile.

Assicurarsi all'atto di acquisto che il prodotto sia provvisto di targhetta. In caso contrario avvertire immediatamente il costruttore e/o il rivenditore. Gli apparecchi sprovvisti di targhetta non devono essere usati pena la decadenza di ogni responsabilità da parte del costruttore. Prodotti sprovvisti di targhetta devono essere ritenuti anonimi e potenzialmente pericolosi.

- 1 - Costruttore
- 2 - Marchio "CE"
- 3 - Modello
- 4 - N° di codice del modello
- 5 - N° di matricola dell'esemplare
- 6 - Potenza assorbita max.
- 7 - Velocità di rotazione max (giri/min)
- 8 - Anno di costruzione

**Fig.1a****Fig.2**

| ENGLISH | FRANÇAIS | DEUTSCH |
|--|--|---|
| <p style="text-align: center;"><u>CORRECT USE</u></p> <p> The vacuum pump has been designed especially for the intake and compression of filtered air. All other uses are to be considered improper.</p> <p style="text-align: center;"><u>INSTALLATION</u></p> <p> LIFTING</p> <p>The vacuum pump must be fitted only with a pair of straps.</p> <p>Allestimenti Pompe Moro S.p.a. has a list of all the elements necessary for correct installation of the vacuum pump.</p> <p>Checking on delivery All the accessories listed on the delivery note must be checked on arrival to ensure that they are in perfect working order. The vacuum pump must not have been damaged during transport. Check the shaft by hand to ensure that it turns easily, fig. 3.</p> <p>Assembly of the vacuum pump The assembly position on the vehicle must be easily accessible and protected from stone chippings or other objects that could damage the vacuum pump. Leave enough room for the pump and all the pipes of the suction and discharge system and to allow free circulation of the cooling air.</p> <p>Alignment of the vacuum pump, fig. 4. The vacuum pump is usually secured to the chassis of the vehicle or on a special bracket. The transmission must rotate in the direction indicated with the arrow on the pulley, the cardan shaft and the coupling. Do not make axial forces when mounting. The couplings must be exactly aligned. <u>The vacuum pump must be mounted horizontally, the maximum tolerance is an inclination of 5°.</u></p> <p>Transmission elements, fig. 5. The transmission may be made by means of a cardan shaft, pulley or coupling. The pulley must be directly connected to the shaft of the vacuum pump, taking great care in assembly:</p> <ul style="list-style-type: none"> • The axes must be parallel, to avoid a different load on the belts; • the pulleys must be aligned, to avoid an excessive axial load on the shaft of the vacuum pump. | <p style="text-align: center;"><u>USAGE CONFORME</u></p> <p> La pompe à vide a été conçue spécialement pour l'aspiration et la compression de l'air filtré. Tout autre usage doit être considéré non conforme.</p> <p style="text-align: center;"><u>INSTALLATION</u></p> <p> SOULEVEMENT</p> <p>Utiliser deux courroies pour soulever la pompe à vide.</p> <p>La Maison Allestimenti Pompe Moro S.p.a. dispose en catalogue de tous les éléments nécessaires à l'installation correcte de la pompe à vide.</p> <p>Contrôle à la réception de la marchandise. Contrôler que tous les accessoires reportés sur le bordereau de livraison soient en bon état. La pompe à vide ne doit pas avoir subi de dommages durant le transport. Agir manuellement sur l'arbre pour contrôler s'il tourne facilement (Fig. 3).</p> <p>Montage de la pompe à vide La pompe doit être montée sur le véhicule dans une position facilement accessible et à l'abri de pierres ou d'autres objets pouvant l'abîmer. Prévoir un espace suffisant pour la pompe et les conduites du système d'aspiration et de vidange et pour permettre à l'air de refroidissement de circuler librement</p> <p>Alignement de la pompe à vide (Fig. 4) Normalement, la pompe à vide est fixée sur le bâti du véhicule ou sur le support prévu à cet effet. Le sens de rotation de la transmission doit coïncider avec celui de la flèche qui se trouve sur la pompe. Eviter de donner des coups sur la poulie, sur l'arbre à cardan et sur le joint. Pas exercer axiales pendant le montage. Aligner parfaitement les joints. <u>Monter la pompe à vide horizontalement, la tolérance maximum d'inclinaison admise est de 5°.</u></p> <p>Éléments de transmission (Fig. 5) La transmission peut être effectuée par l'arbre à cardan, la poulie ou le joint. On peut relier directement la poulie à l'arbre de la pompe à vide, en soignant tout particulièrement le montage.</p> <ul style="list-style-type: none"> • Les axes doivent être parallèles pour éviter une charge différente sur les courroies; • les poulies doivent être alignées pour éviter une charge axiale excessive sur l'arbre de la pompe à vide. | <p style="text-align: center;"><u>EIGENTLICHER VERWENDUNGSZWECK</u></p> <p> Die Vakuumpumpe wurde ausdrücklich für das Saugen und Verdichten von filtrierter Luft entwickelt. Jede andere Verwendung ist als uneigentlich anzusehen.</p> <p style="text-align: center;"><u>INSTALLATION</u></p> <p> HEBEN</p> <p>Die Vakuumpumpe darf ausschließlich Mit einem Paar Riemen gehoben werden.</p> <p>Die Firma Allestimenti Pompe Moro S.p.a. ist in der Lage alle für die korrekte Installation der Vakuumpumpe erforderlichen Elemente zu liefern (siehe Preislisten).</p> <p>Kontrolle bei Eingang Alle auf dem Lieferschein aufgeführten Teile müssen beim Empfang auf ihren perfekten Zustand kontrolliert werden. Die Vakuumpumpe darf keine Transport-schäden aufweisen. Von Hand kontrollieren, ob die Welle frei dreht (Abb.3).</p> <p>Montage der Vakuumpumpe Die Montageposition auf dem Fahrzeug muß leicht zugänglich sein und soll die Pumpe gegen umherfliegende Steine und ähnliches schützen. . Ausreichenden Raum für die Pumpe und alle Leitungen der Saug- und Auslaßanlage vorsehen, damit die Kühlluft frei zirkulieren kann</p> <p>Ausfluchtung der Vakuumpumpe, Abb.4. Die Vakuumpumpe wird normalerweise am Fahrzeuggahmen oder auf einer speziellen Konsole befestigt. Die Drehrichtung des Antriebs muß der Richtung des auf der Pumpe angebrachten Pfeils entsprechen. Vermeiden Sie Schlagswirkungen auf die Riemenscheibe, die Kardanwelle und die Kupplung. Machen Sie keine Längskräfte mit der Montage. Die Kupplungen exakt fluchten. <u>Die Vakuumpumpe muß horizontal montiert werden, es werden max. 5° Schräge toleriert.</u></p> <p>Antriebs-elemente, Abb.5. Der Antrieb kann über Kardanwelle, Riemenscheibe oder Kupplung erfolgen. Die Riemenscheibe kann direkt mit der Welle der Vakuumpumpe verbunden werden, wobei bei der Montage besonders sorgfältig vorgegangen werden muß:</p> <ul style="list-style-type: none"> • Die Achsen müssen parallel sein, damit unterschiedliche Belastungen der Riemen vermieden werden; • die Riemenscheiben müssen miteinander gefluchtet sein, damit eine übermäßige Axialbelastung der Welle der Vakuumpumpe vermieden wird. |

USO PROPRIO

La pompa per vuoto è stata progettata espressamente per aspirazione e compressione di aria filtrata.

Ogni altro uso è da considerarsi improprio.

INSTALLAZIONE**SOLLEVAMENTO**

Sollevarre la pompa per vuoto esclusivamente con una coppia di fasce.

La Allestimenti Pompe Moro S.p.a. dispone a listino di tutti gli elementi necessari per la corretta installazione della pompa per vuoto.

Controllo al ricevimento

Tutti gli accessori riportati sulla bolla di consegna devono essere controllati all'arrivo per assicurarsi che siano in perfetto stato d'uso. La pompa per vuoto non deve aver subito danni durante il trasporto. Controllare manualmente che l'albero ruoti con facilità (fig. 3).

Montaggio della pompa per vuoto

La posizione di montaggio sul veicolo deve essere facilmente accessibile e protetta da pietrisco o altri oggetti che potrebbero danneggiare la pompa per vuoto.

Prevedere spazio sufficiente per la pompa e per tutte le tubazioni dell'impianto di aspirazione e scarico e per consentire la libera circolazione dell'aria di raffreddamento

Allineamento della pompa per vuoto, (fig. 4).

La pompa per vuoto viene di solito fissata sul telaio del veicolo o sull'apposita mensola. Il senso di rotazione della trasmissione deve coincidere con quello della freccia posta sulla pompa stessa. Evitare colpi sulla puleggia, sull'albero cardanico e sul giunto. Non esercitare forze casuali durante il montaggio. Allineare esattamente i giunti. La pompa per vuoto deve essere montata orizzontalmente, vengono tollerati 5° di inclinazione massima.

Elementi di trasmissione, (fig. 5).

La trasmissione può avvenire tramite albero cardanico, puleggia o giunto. La puleggia può essere direttamente connessa con l'albero della pompa per vuoto, curandone particolarmente il montaggio:

- gli assi devono essere paralleli per evitare un carico differente sulle cinghie;
- le pulegge devono essere allineate, per evitare un eccessivo carico assiale sull'albero della pompa per vuoto.

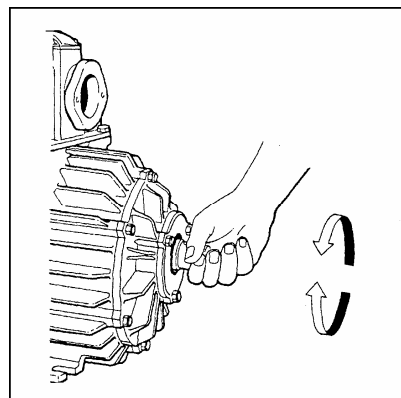

Fig.3

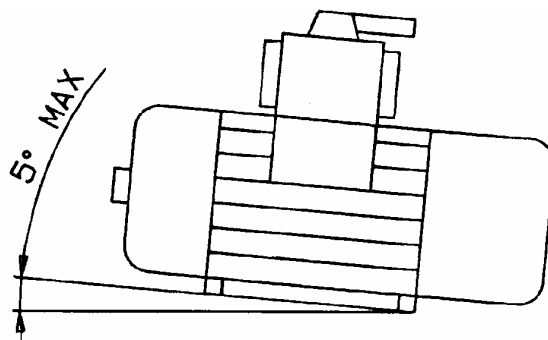

Fig.4

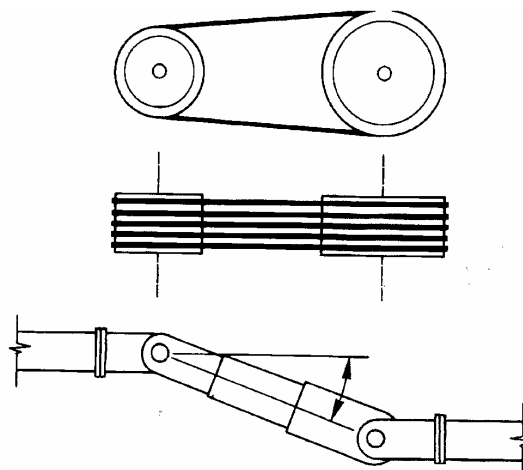













Fig.5

| ENGLISH | FRANÇAIS | DEUTSCH |
|---|---|---|
| <p> The pump pulley cannot be used as a drive for other mechanisms.</p> <p> Use only V-belts with profiles SPA, SPB, SPX.</p> <p>For transmission with a cardan shaft, do not exceed the max. shaft inclination of 15°.</p> <ul style="list-style-type: none"> • The transmission parts must not be coupled by hammering them. <p>Suction pipes</p> <p>Avoid installing pipes subject to internal corrosion. When assembled, the pipe must be clean on the inside; accurately remove all welding slag, filings, rust or other foreign bodies.</p> <p>Preventing the suction of liquids and foreign bodies</p> <p>The vacuum pump must be protected against the suction of liquids or foreign bodies by means of a safety valve with an automatically closing float and a suitable safety filter.</p> <p>Any intake of liquids or foreign bodies could cause breaking of the vanes, the shaft or the pump body. For this reason Allestimenti Pompe Moro S.p.a. has prepared a double protection (fig. 8 page 15).</p> <p>Non-return valve</p> <p>A special non-return valve is fitted in the vacuum pump. This valve closes when the pump is stopped, thus preventing the return of fluids and inverse pump rotation.</p> <p>Four-way valve</p> <p>(Switch valve, fig. 6) The four-way valve puts the tank in communication with the suction mouth or with the delivery mouth of the vacuum pump. It enables both vacuum and pressure to be created inside the tank. The valve is controlled by the lever on the top of the pump.</p> <p> Operate the switch valve only when wearing gloves.</p> <p> During installation, leave sufficient space for air to circulate around the vacuum pump so as to allow cooling.</p> | <p> Il est interdit d'utiliser la poulie de la pompe à vide pour actionner d'autres appareils.</p> <p> N'utiliser que des courroies trapézoïdales avec profils SPA; SPS; SPX.</p> <p>Pour la transmission avec l'arbre à cardan, il est conseillé de ne pas incliner l'arbre de plus de 15°.</p> <ul style="list-style-type: none"> • Ne pas assembler les éléments de la transmission à coups de marteau. <p>Conduites d'aspiration</p> <p>Éviter d'installer des tubes qui se corrodent intérieurement. Nettoyer l'intérieur des tubes avant de les monter en éliminant soigneusement tout résidu de soudure et de limage, la rouille ou autres corps étrangers éventuels.</p> <p>Prévention de l'aspiration de liquides et de corps étrangers</p> <p>Prévoit une soupape de sûreté à flotteur à fermeture automatique et un filtre de sûreté approprié pour éviter que la pompe à vide n'aspire des liquides ou des corps étrangers.</p> <p>Une aspiration éventuelle de liquides ou de corps étrangers peut provoquer la rupture des palettes, de l'arbre et du corps de la pompe. C'est pourquoi la Maison Allestimenti Pompe Moro S.p.a. a mis au point une double protection (Fig. 8 page 13).</p> <p>Soupape de non retour</p> <p>La pompe à vide dispose d'une soupape spéciale de non retour qui se ferme quand la pompe s'arrête en évitant par conséquent le retour des fluides et la rotation inverse de la pompe.</p> <p>Soupape à quatre voies (Soupape de déviation, Fig. 6) La soupape à quatre voies permet de mettre le réservoir en communication avec la bouche aspirante ou avec la bouche foulante de la pompe à vide. Elle permet de créer aussi bien le vide que la pression à l'intérieur du réservoir. La soupape est commandée par le levier qui se trouve au sommet de la pompe.</p> <p> Mettre des gants pour actionner la soupape de déviation.</p> <p> Durant le montage, prévoir un espace suffisant pour la circulation de l'air autour de la pompe à vide afin d'en garantir le refroidissement.</p> | <p> Die Riemenscheibe der Pumpe darf nicht als Vorgelege für andere Antriebe verwendet werden.</p> <p> Verwenden Sie ausschließlich Keilriemen mit Profilen SPA; SPS; SPX.</p> <p>Bei Antrieb mit Kardanwelle darf die Schräge der Welle selbst nicht mehr als 15° betragen.</p> <ul style="list-style-type: none"> • Die Antriebs Elemente dürfen auf keinen Fall mit Hilfe von Hammerschlägen gekuppelt werden. <p>Saugleitungen</p> <p>Vermeiden Sie Rohre die innen korrodieren. Bei der Montage müssen die Rohrleitungen innen sauber sein; Bearbeitungsrückstände, Rost und andere Fremdkörper müssen sorgfältig entfernt werden.</p> <p>Vorbeugung gegen das Ansaugen von Flüssigkeiten und Fremdkörpern</p> <p>Die Vakuumpumpe muß mittels eines Schwimmer-Ventils mit Automatik-verschluß und einem geeigneten Schutzfilter gegen das Ansaugen von Flüssigkeiten und Fremdkörpern geschützt werden. Das eventuelle Ansaugen von Flüssigkeiten oder Fremdkörpern kann die Schaufeln, die Welle und den Pumpenkörper beschädigen. Zu diesem Zweck hat die Firma Allestimenti Pompe Moro S.p.a. eine zweifache Sicherung entwickelt. (Abb. 8, Seite 13).</p> <p>Rückschlagventil</p> <p>Die Vakuumpumpe ist mit einem speziellen Rückschlagventil ausgestattet, das beim Ausschalten der Pumpe schließt und so den Rückfluß der Fluide und die entgegengesetzte Drehung der Pumpe verhindert.</p> <p>4- Wege-Ventil (Abzweigventil, Abb. 6). Das 4-Wege-Ventil ermöglicht die Verbindung des Tanks mit dem Saug- oder Auslaßstutzen der Vakuumpumpe. Dadurch kann im Innern des Tanks sowohl Vakuum, als auch Druck erzeugt werden. Das Ventil wird mittels des Hebels an der Oberseite der Pumpe gesteuert.</p> <p> Bedienen Sie das Abzweigventil ausschließlich mit Handschuhen.</p> <p> Kalkulieren Sie bei der Installation genügend Raum für die Zirkulierung der Luft um die Vakuumpumpe herum ein, damit die Kühlung sichergestellt wird.</p> |



Non si può utilizzare la puleggia della pompa come rinvio per altri azionamenti.



Usare solo cinghie trapezoidali con profili SPA; SPB; SPX.

Per la trasmissione con albero cardanico, si raccomanda di non superare l'inclinazione max. di 15° dell'albero stesso.

- Gli elementi della trasmissione non devono essere accoppiati a colpi di martello.

Tubazioni di aspirazione

Evitare di installare tubi che si corrodono internamente. Al montaggio la tubazione deve essere pulita internamente; eliminare accuratamente ogni scoria di saldatura, limatura, ruggine o altri eventuali corpi estranei.

Prevenzione della aspirazione di liquidi e corpi estranei

La pompa a vuoto deve essere protetta dall'aspirazione di liquidi o corpi estranei con una valvola di sicurezza a galleggiante a chiusura automatica e un filtro di sicurezza idoneo.

Un'eventuale aspirazione di liquidi o corpi estranei può provocare la rottura delle palette, dell'albero e del corpo pompa. A questo scopo la **Allestimenti Pompe Moro S.p.a.** ha messo a punto una doppia protezione (fig. 8 pag. 13).

Valvola di non ritorno

Nella pompa per vuoto è installata una speciale valvola di non ritorno che si chiude quando la pompa viene fermata evitando quindi il ritorno dei fluidi e la rotazione inversa della pompa.

Valvola a quattro vie (Valvola deviatrice, fig. 6)

La valvola a quattro vie, permette di mettere in comunicazione il serbatoio con la bocca aspirante, o con la bocca premente della pompa per vuoto. Consente di creare all'interno del serbatoio sia il vuoto che la pressione.

La valvola viene comandata dalla leva posta sulla sommità della pompa.

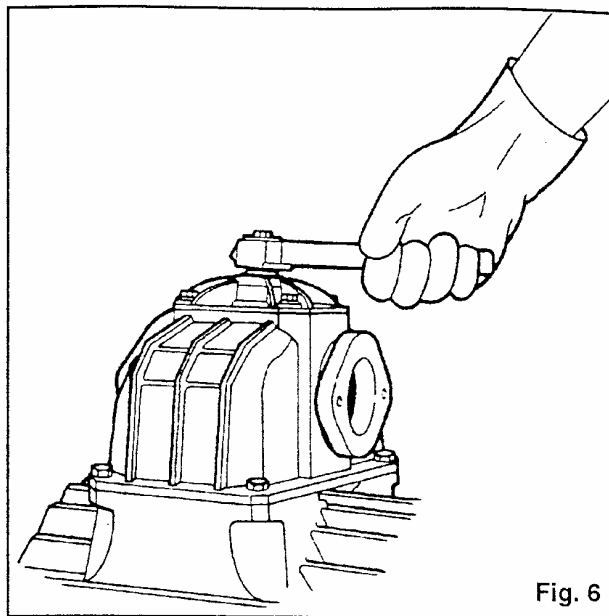







Fig. 6



Azionare la valvola deviatrice esclusivamente con l'uso di guanti.



Durante l'installazione, prevedere uno spazio sufficiente per la circolazione dell'aria attorno alla pompa per vuoto, al fine di permetterne il raffreddamento.

| ENGLISH | FRANÇAIS | DEUTSCH |
|---|---|--|
| <p style="text-align: center;"><u>SYSTEM DIAGRAM</u></p> <p>(See fig. page 13)</p> <p>KEY</p> <p>1 - Suction pipe with shutter 2 - Tank 3 - Manhole with float valve 4 - Cyclone filter 5 - Safety filter 6 - Vacuum pump 7 - Discharge filter 8 - Pressure gauge (-1 / +3 bar) 9 - Maximum pressure valve (+ 1 bar) 10- Safety valve (-0.8 bar optional) 11 -Thermometer (0 / +20°C) 12 -Drainage cocks (3/8" - 1")</p> <p> Principal pipes (in a double line) 4". (recommended)</p> <p> The thermometer (POS. 11) must be installed immediately downstream from the pump. (Max. distance 50 mm.)</p> | <p style="text-align: center;"><u>SCHEMA DE L'INSTALLATION</u></p> <p>(Voir fig. page 13)</p> <p>LEGENDE</p> <p>1 - Tube d'aspiration avec vanne 2 - Citerne 3 - Trou d'homme avec soupape à flotteur 4 - Filtre à cyclone 5 - Filtre de sûreté 6 - Pompe à vide 7 - Filtre de vidange 8 - Manomètre (-1/ +3 bars) 9 - Soupape de pression maximum (+ 1 bar) 10 - Soupape de sûreté (0,8 bar en option) 11 - Thermomètre 12 – Drainages</p> <p> Tubes principaux (en double ligne) 4" . (conseillés)</p> <p> Il faut installer le thermomètre (POS. 11) juste après la pompe (à 50 mm au maximum)</p> | <p style="text-align: center;"><u>ANLAGEN-SCHEMA</u></p> <p>(Siehe seite 13)</p> <p>LEGENDE</p> <p>1 - Saugrohr mit Schieber 2 - Kessel 3 - Domloch mit Schwimmer-Ventil 4 - Zyklonfilter 5 - Schutzfilter 6 - Vakuumpumpe 7 - Auslaßfilter 8 - Manometer (-1 / +3 bar) 9 - Höchstdruckventil (+ 1 bar) 10 - Sicherheitsventil (-0,8 bar Optional) 11 -Thermometer (0/+200°C) 12 - Dränungen (3/8" - 1")</p> <p> Hauptleitungen (doppelt) 4". (Empfohlene Werte)</p> <p> Der Thermometer (POS.11) muß gleich nach der Pumpe eingeschaltet werden (mit einem Abstand von max. 50 mm).</p> |

SCHEMA DI IMPIANTO

Fig. 8

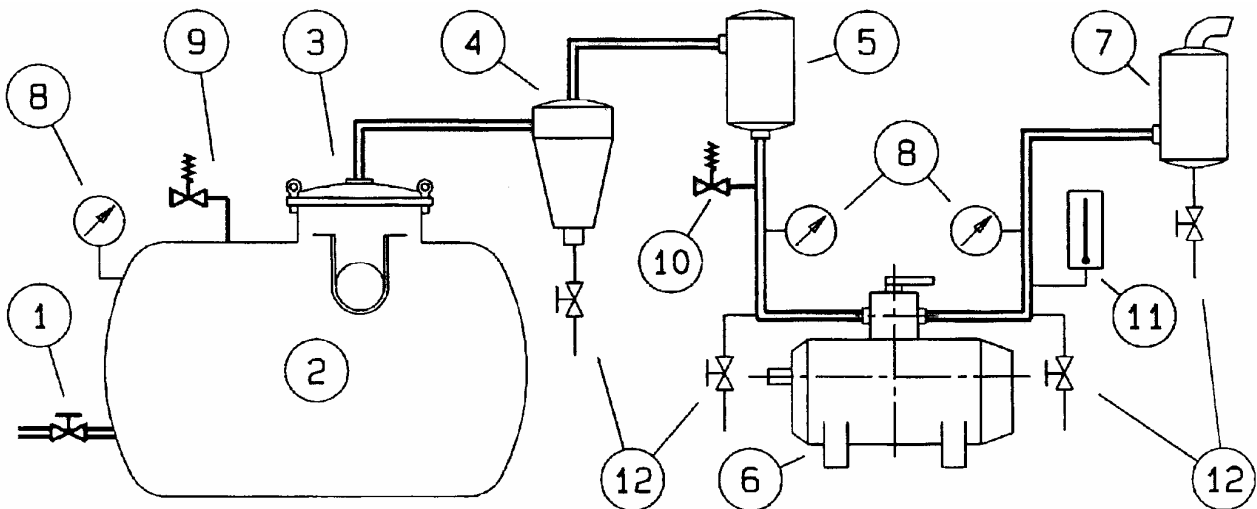

LEGENDA

1 - Tubo di aspirazione con saracinesca

2 - Cisterna

3 - Passo d'uomo con valvola a galleggiante

4 - Filtro a ciclone

5 - Filtro di sicurezza

6 - Pompa per vuoto

7 - Filtro di scarico

8 - Manometro (-1 / +3 bar)

9 - Valvola di massima pressione (+ 1 bar)



10 - Valvola di sicurezza (-0,8 bar opzionale)

11 - Termometro (0 / + 200 °C)

12 - Drenaggi (3/8" - 1")

 Tubi principali (in doppia linea) 4" (raccomandati)

Il termometro (POS. 11) deve essere installato immediatamente a valle della pompa. (Max. 50 mm. di distanza).

| ENGLISH | FRANÇAIS | DEUTSCH |
|--|--|--|
| <p style="text-align: center;"><u>LUBRICANTS</u></p> <p> The vacuum pump is supplied without oil. Fill it before use. (See table of technical characteristics on page 5).</p> <p>Lubricate the front and rear bearing through the grease nipple (Fig. 11 pag.19) ,with 2 gr of grease every 100 hours).</p> <p>Check the level of the disposable oil in the vacuum pump from time to time by means of the dipstick (fig.9).</p> <p>Additional lubrication. 1 - Vacuum pump. 2 - Extra tank. 3 - Tap. 4 - Pipe. To allow correct lubrication of the vacuum pump even in the first minutes of cold operation, it is advisable to install an extra external oil container and to connect it to the pump intake by means of a pipe with a tap. Turn on the tap and let about 0.2 -0'. 3 kg of oil flow freely into the pump, then turn off the tap. This procedure must also be followed when the pump is expected to be working under pressure for periods of more than 10 minutes.</p> <p>This procedure must also be followed when the pump is expected to be subject to extreme operating conditions:</p> <ul style="list-style-type: none"> • surrounding temperature 35°C • suction or compression of aggressive substances | <p style="text-align: center;"><u>LUBRIFIANTS</u></p> <p> La pompe à vide est fournie sans huile. Il faut donc effectuer le remplissage de l'huile avant de l'utiliser (Voir tableau des données techniques page 5).</p> <p>Graissage le roulement avant et arriere (Fig. 11 pag.19), (utiliser environ 2 gr de graisse toutes les 100 heures).</p> <p>Contrôler régulièrement le niveau d'huile du réservoir de la pompe à vide à l'aide de la jauge prévue à cet effet (fig.9).</p> <p>Lubrification additionnelle. 1 - Pompe à vide. 2 - Réservoir additionnel. 3 - Robinet. 4 - Tube. Afin de permettre une lubrification correcte de la pompe à vide également durant les premières minutes de fonctionnement à froid, il est conseillé d'installer un récipient supplémentaire externe d'huile et de le relier à un tube ayant un robinet à l'aspiration de la pompe. Ouvrir le robinet et laisser couler librement environ 0,2 □ 0,3 kg. d'huile dans la pompe puis refermer le robinet. Il est également important de prendre cette précaution lorsqu'on prévoit des périodes de fonctionnement à des pressions supérieures à 10 minutes.</p> <p>Cette perspicacité doit être utilisée aussi quand on prévoit emplois lourdes pour la pompe :</p> <ul style="list-style-type: none"> • température extérieure 35°C • aspiration ou compression de substances agressives | <p style="text-align: center;"><u>SCHMIERMITTEL</u></p> <p> Die Vakuumpumpe wird ohne Öl geliefert und muß vor dem Einsatz folglich aufgefüllt werden. (Siehe Technische Daten Seite 5).</p> <p>Von Zeit zu Zeit Schmierien Sie in den Punkte, die in Fig. 11, Seite 19 gezeigt sind (2 Gr Schmierfett jede 100 Betriebsstunde).</p> <p>Den Stand des Verbrauchsöls der Vakkumpumpe regelmäßig mit Hilfe des Meßstabs kontrollieren (Abb.9).</p> <p>Zusätzliche Schmierung. 1 - Vakuumpumpe. 2 - Zusatztank. 3 - Hahn. 4 - Rohr. Um auch während der ersten Minuten des kalten Betriebs die korrekte Schmierung der Vakuumpumpe sicherzustellen, empfiehlt es sich außen ein zusätzliches Ölgefäß zu installieren und dieses mittels einem Rohr mit Hahn an dem Ansaugteil der Pumpe anzuschließen. Den Hahn öffnen und ungefähr 0,2 □ 0,3 kg Öl frei in die Pumpe fließen lassen, dann den Hahn schließen. Diese Maßnahme muß auch dann getroffen werden, wenn ein Betrieb unter Druck von mehr als 10 Minuten zu erwarten ist.</p> <p>Diese maßnahme muß auch dann getroffen werden, wenn ein Betrieb unter extreme Einsatzbedingungen:</p> <ul style="list-style-type: none"> • Umgebungstemperaturen >35 °C • Saugen oder Druckung von aggressiv Materialien |

LUBRIFICANTI

La pompa per vuoto viene fornita senza olio.
Prima dell'uso provvedere al rifornimento.

Vedi tab. caratteristiche tecniche pag. 5.

Ingrassare periodicamente nei punti indicati in Fig. 11 a pag.19 (2 grammi di grasso ogni 100 ore di funzionamento).

Controllare periodicamente il livello dell'olio a perdere della pompa per vuoto tramite l'asta di controllo livello (Fig.9).

Lubrificazione aggiuntiva Fig.10.

- 1 - Pompa per vuoto.
- 2 - Serbatoio aggiuntivo.
- 3 - Rubinetto.
- 4 - Tubo.

Per permettere una corretta lubrificazione della pompa per vuoto anche nei primi minuti di funzionamento a freddo è consigliabile installare un recipiente supplementare esterno di olio e collegarlo con un tubo munito di rubinetto all'aspirazione della pompa. Aprire il rubinetto e lasciare scorrere liberamente nella pompa circa 0,2 ÷ 0,3 kg di olio, poi richiudere il rubinetto. Questo accorgimento deve essere usato anche quando si prevedono impieghi gravosi per la pompa:

- temperatura esterna 35°C
- aspirazione o compressione di sostanze aggressive

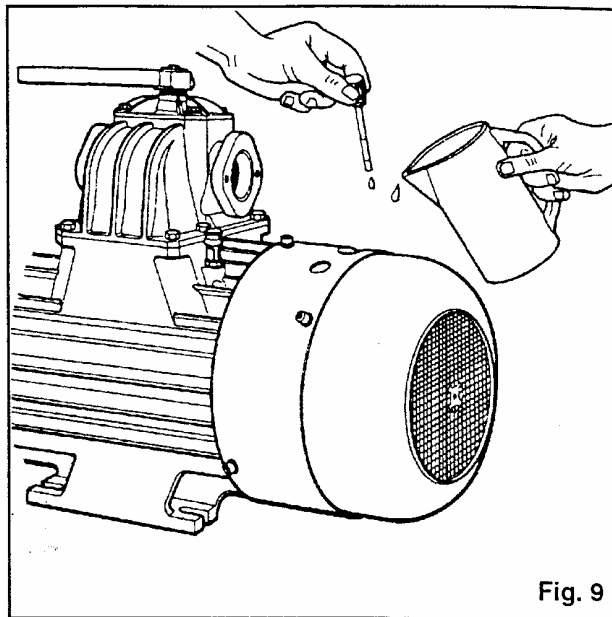

Fig. 9

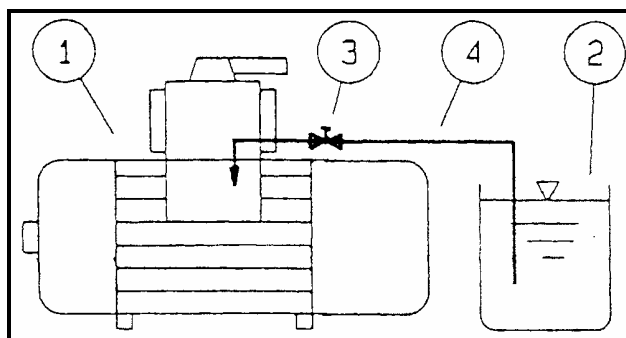





Fig.10

| ENGLISH | FRANÇAIS | DEUTSCH |
|--|---|---|
| <p>RECOMMENDED OILS (See table page 17).</p> <p>SUMMER SAE 40 WINTER SAE 30</p> <p>Use SAE 50 for temperatures above 40°C and SAE 20/W40 for temperatures below 5°C. Pay great attention to extremely low temperatures; in the event of necessity, contact an authorized dealer or Allestimenti Pompe Moro S.p.a.</p> <p>MINIMUM SPECIFICATIONS ALLOWED API CD CCMC D4 MIL L-2104 E (level) MB 227.0 (monograde) MB 227.1(multigrade)</p> <p> Use only HD oil.</p> | <p>HUILES RECOMMANDEES (Voir tableau page 17)</p> <p>ETE SAE 40 HIVER SAE 30</p> <p>Utiliser SAE 50 pour des températures supérieures à 40°C et SAE 20/W40 pour des températures inférieures à 5°C. Faire très attention quand les températures sont extrêmement basses; en cas de besoin, contacter un revendeur autorisé ou directement la Maison Allestimenti Pompe Moro S.p.a.</p> <p>CARACTERISTIQUES MINIMUMS ADMISES API CD CCMC D4 MIL L-2104 E (level) MB 227.0 (monograde) MB 227.1(multigrade)</p> <p> N'utiliser que de l'huile HD.</p> | <p>EMPFOHLENE ÖLE (Siehe seite 17)</p> <p>SOMMER SAE 40 WINTER SAE 30</p> <p>Verwenden Sie SAE 50 für Temperaturen über 40°C und SAE 20/W40 für Temperaturen unter 5°C. Gehen Sie bei extrem niedrigen Temperaturen mit größter Vorsicht vor und wenden Sie sich erforderlichenfalls an einen autorisierten Händler oder die Firma Allestimenti Pompe Moro S.p.a.</p> <p>ZULÄSSIGE MINDEST-SPEZIFIKATIONEN API CD CCMC D4 MIL L-2104 E (level) MB 227.0 (monograde) MB 227.1(multigrade)</p> <p> Benutzen nur HD Öle.</p> |

OLI RACCOMANDATI

| | | |
|-------------------|--------------------------------------|-------------------------|
| IP AXIA D | ESSO ESSOLUBE HDX | MONOGRADE |
| IP SUPERAXIA PLUS | ESSO HEAVY TRUCK DIESEL MOTOR OIL | MULTIGRADE |
| IP TAURUS TURBO | ESSO SUPER DIESEL OIL TD | |
| IP GEO 1 | ESSO UNIFARM | AGRICULTURAL MULTIGRADE |

ESTATE SAE 40
INVERNO SAE 30



Usare SAE 50 per temperature sopra i 40°C e SAE 20/W40 per temperature sotto i 5°C.
Prestare la massima attenzione per le temperature estremamente basse; in caso di necessità contattare un rivenditore autorizzato o la **Allestimenti Pompe Moro S.p.a.**

MINIME SPECIFICHE AMMESSE

API CD
CCMC D4
MIL L-2104 E (level)
MB 227.0 (monograde)
MB 227.1 (multigrade)



Usare solo oli HD

| ENGLISH | FRANÇAIS | DEUTSCH |
|---|--|--|
| <p style="text-align: center;"><u>COMMISSIONING THE SYSTEM</u></p> <ul style="list-style-type: none"> • Ensure that the level of the disposable oil in the tank for the vacuum pump is never less than the minimum shown; top up if necessary. • Open all the shutters and valves. • Unscrew the cover of the dripper and fill with oil. Repeat the operation 4 or 5 times. • Start the vacuum pump slowly for a brief period (about 300 rpm) to check the direction of rotation. <p style="text-align: center;"> Check that rotation is in the same direction indicated by the arrow on the pump. If not, contact an authorized dealer or Allestimenti Pompe Moro S.p.a.</p> <ul style="list-style-type: none"> • Read the pressure gauges to see whether the switch valve is producing vacuum or pressure; see "System diagram" on page 13. After all this has been checked, the pump is ready to start work. <p><u>ATTENTION:</u> Never work with a rotation speed slower than 900 rpm, to avoid knocking and wear of the pump body.</p> <p>1 - Vane wear sight hole. 2 - Cap for loading the disposable lubricating oil. 3 - Switch valve operating lever. 4 - Grease nipple. 5 - Discharge cup.</p> | <p style="text-align: center;"><u>MISE EN SERVICE DE L'INSTALLATION</u></p> <ul style="list-style-type: none"> • Contrôler que le niveau d'huile du réservoir de la pompe à vide ne soit jamais inférieur au minimum indiqué; rajouter de l'huile si nécessaire. • Ouvrir toutes les vannes et les soupapes. • Dévisser le couvercle du graisseur et remplir d'huile. Répéter l'opération 4 ou 5 fois. • Amorcer lentement et brièvement la pompe à vide (environ 300 r.p.m.) pour contrôler le sens de rotation. <p style="text-align: center;"> Contrôler que le sens de rotation soit celui indiqué sur la flèche qui se trouve sur la pompe. Si ce n'est pas le cas, contacter un revendeur agréé ou directement la Maison Allestimenti Pompe Moro S.p.a. Contrôler qu'il se produise du vide ou de la pression à l'aide de la soupape de déviation en contrôlant sur les manomètres, voir "Schéma de l'installation" page 13. La pompe à vide est alors prête à fonctionner.</p> <p><u>ATTENTION:</u> Ne jamais travailler avec un nombre de tours inférieur à 900 r.p.m. pour éviter le martèlement et l'usure du corps de la pompe.</p> <p>1 - Trou de contrôle d'usure des palettes. 2 - Bouchon pour le contrôle et le remplissage de l'huile du réservoir. 3 - Levier qui actionne la soupape de déviation. 4 - Graisseur. 5 - Bouchon de vidange.</p> | <p style="text-align: center;"><u>INBETRIEBSETZUNG DER ANLAGE</u></p> <ul style="list-style-type: none"> • Sicherstellen, daß der Stand des Verbrauchöls im Tank der Vakuumpumpe nie unter die Mindestmarke absinkt; erforderlichenfalls auffüllen; • Alle Schieber und Ventile öffnen; • Den Deckel der Füllöffnung aufschrauben und Öl einfüllen. Diesen Vorgang 4 bis 5 Mal wiederholen. • Die Vakuumpumpe langsam und kurzfristig laufen lassen (zirka 300 U/min.), um die Drehrichtung zu kontrollieren. <p style="text-align: center;"> Sicherstellen, daß die Drehrichtung mit der Pfeilrichtung übereinstimmt. Im gegenteiligen Fall wenden Sie sich am besten an einen autorisierten Händler oder Allestimenti Pompe Moro S.p.a.</p> <ul style="list-style-type: none"> • Durch Ablesen der Manometer kontrollieren, ob über das Abzweigventil Vakuum oder Druck erzeugt wird (siehe "Anlagen-Schema", Seite 13. Nachdem all diese Kontrollen durchgeführt wurden, ist die Vakuumpumpe betriebsbereit. <p><u>ACHTUNG!</u> Arbeiten Sie nie mit einer Drehzahl von weniger als 900 U/min, um das Klopfen und den Verschleiß des Pumpenkörpers zu verhindern.</p> <p>1 - Öffnung für die Kontrolle des Schaufelverschleißes. 2 - Deckel mit Meßstab für Auffüllen des Schmieröls. 3 - Hebel Abzweigventil. 4 - Schmiernippel. 5 - Ablassdeckel</p> |

MESSA IN ESERCIZIO DELL' IMPIANTO

- Assicurarsi che il livello dell'olio a perdere nel serbatoio della pompa per vuoto non sia mai inferiore al minimo indicato; riempire se necessario;
- Aprire tutte le saracinesche e le valvole;
- Avviare lentamente e brevemente la pompa per vuoto (circa 300 giri/min) per controllare il senso di rotazione.



Verificare che il senso di rotazione sia quello indicato sulla freccia posta sulla pompa.

In caso contrario contattare un rivenditore autorizzato o la **Allestimenti Pompe Moro S.p.a.**

- Controllare se si produce vuoto o pressione tramite la valvola deviatrice leggendo i manometri vedi "Schema impianto" pag. 15.

Dopo aver verificato tutto ciò la pompa per vuoto è pronta per operare.

ATTENZIONE! Mai lavorare con un numero di giri inferiore a 900 giri/min per evitare martellamenti e usura del corpo pompa.

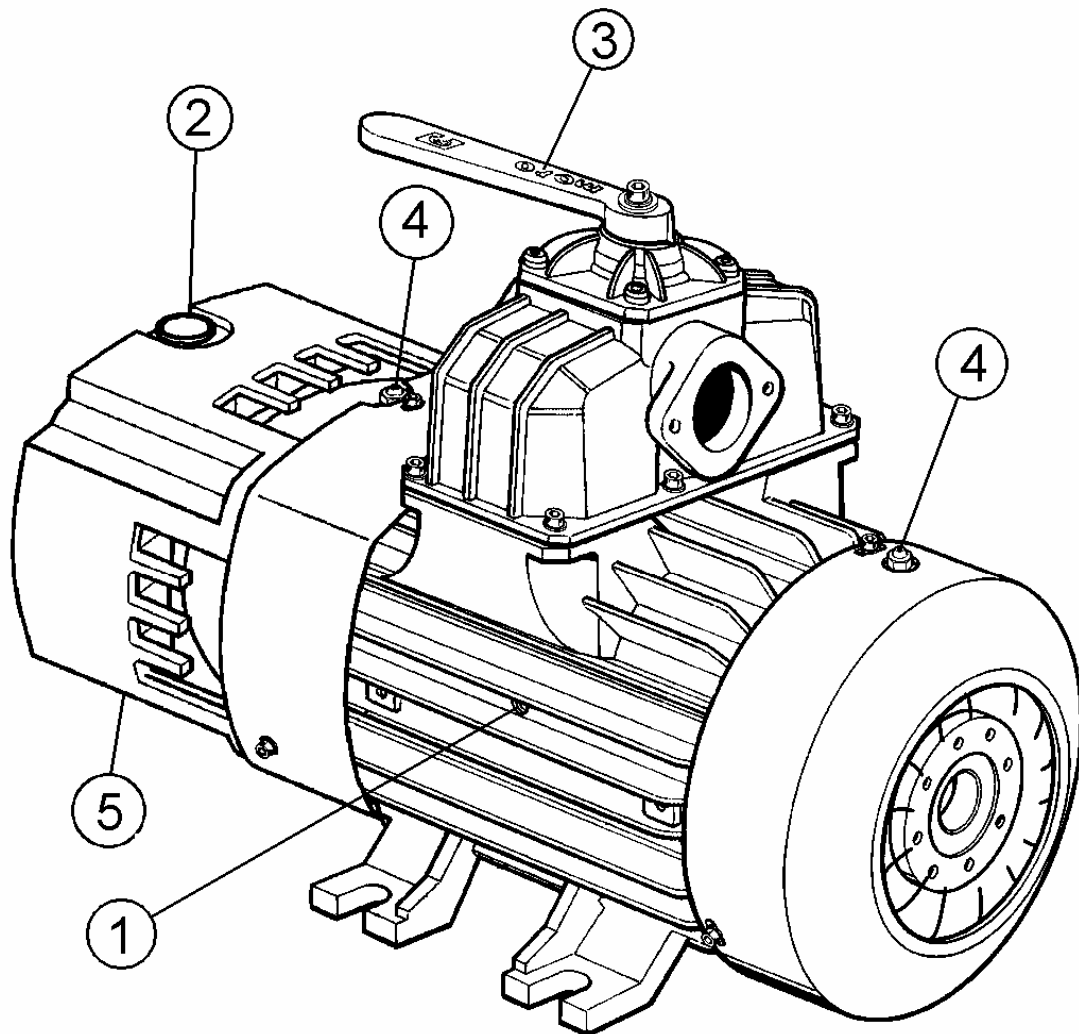

Fig. 11















1 - Foro controllo usura palette

2 - Tappo con astina per controllo e carico olio di lubrificazione a perdere.

3 - Leva azionamento valvola deviatrice

4 - Ingrassatori

5 - Tappo scarico olio

| ENGLISH | FRANÇAIS | DEUTSCH |
|--|---|---|
| <p align="center"><u>PRECAUTIONS DURING USE OF THE PUMP</u></p> <p> During use, never touch the pump with your hands: danger of burning. Use gloves to operate the switch valve.</p> <p> The Manufacturer declines all responsibility for damage caused by the failure to observe the instructions for installation, use and maintenance given in this manual.</p> <p> Do not exceed the maximum rotating speed indicated on the plate, see page 9.</p> <p> Keep the rotating speed within the range indicated in the table on page 5.</p> | <p align="center"><u>PRECAUTIONS A PRENDRE EN UTILISANT LA POMPE</u></p> <p> Ne pas toucher la pompe avec les mains durant le fonctionnement: risque de brûlure. Mettre des gants pour actionner la soupape de déviation.</p> <p> Le constructeur décline toute responsabilité pour les dommages causés par l'observation des normes d'installation, d'utilisation et d'entretien contenues dans ce manuel.</p> <p> Ne pas dépasser le régime maximum de rotation indiqué sur la plaque (voir page 9).</p> <p> Le régime de rotation doit se situer dans la plage indiquée sur le tableau de la page 5.</p> | <p align="center"><u>VVORSICHTSMASSNAHMEN WÄHREND DEM GEBRAUCH DER PUMPE</u></p> <p> Während dem Gebrauch die Pumpe nicht mit den Händen berühren: Verbrennungsgefahr. Fassen Sie den Hebel des Abzweigventils unbedingt mit Handschuhe an.</p> <p> Der Hersteller haftet nicht für solche Schäden, die durch die Nichtbeachtung der in dieser Betriebsanleitung enthaltenen Vorschriften für Installation, Gebrauch und Wartung entstehen.</p> <p> Die auf Seite 9 angegebene maximale Einlauf-Drehzahl darf nicht überschritten werden.</p> <p> Halten Sie den in der Tabelle der Seite 5 angegebenen Drehzahlbereich ein.</p> |
| <p align="center"><u>PRESSURE</u></p> <p>See table page 5.</p> | <p align="center"><u>PRESSION</u></p> <p>Voir tableau page 5.</p> | <p align="center"><u>DRUCK</u></p> <p>Sehen Sie Tabelle Seite 5.</p> |
| <p align="center"><u>TEMPERATURE</u></p> <p> The temperature at discharge of the vacuum pump must never be more than 200°C. If the temperature is too high, stop the vacuum pump and let it cool down.</p> | <p align="center"><u>TEMPERATURE</u></p> <p> La température de vidange de la pompe à vide ne doit jamais dépasser 200°C. Dans le cas contraire, arrêter la pompe pour qu'elle puisse se refroidir.</p> | <p align="center"><u>TEMPERATUR</u></p> <p> Die Temperatur am Auslaß der Vakuumpumpe darf auf keinen Fall 200°C überschreiten. In einem solchen Fall die Vakuumpumpe ausschalten und abkühlen lassen.</p> |
| <p align="center"><u>MAXIMUM USING TIME (MINUTES)</u></p> <p>See table page 5.</p> | <p align="center"><u>TEMPS MAXIMUM D'UTILISATION (MINUTES)</u></p> <p>Voir tableau page 5.</p> | <p align="center"><u>HÖCHSTBETRIEBSZEIT (MINUTEN)</u></p> <p>Sehen Sie Tabelle Seite 5.</p> |
| <p>IMPORTANT The time indicated refers to normal working conditions with intermittent duty. For harsh conditions or for continuous duty, contact a Allestimenti Pompe Moro S.p.a. authorized dealer.</p> | <p>IMPORTANT : Le temps indiqué vaut dans des conditions normales de fonctionnement, pour un emploi discontinu. Pour des emplois lourds ou pour une utilisation continue, contacter un revendeur autorisé de Allestimenti Pompe Moro S.p.a.</p> | <p>WICHTIG: Der angegebene Zeitraum bezieht sich auf normale Betriebsbedingungen bei diskontinuierlicher Funktion. Für belastenden Betrieb oder Dauerbetrieb wenden Sie sich an einen von der Firma Allestimenti Pompe Moro S.p.a. autorisierten Händler.</p> |

PRECAUZIONI DURANTE L' USO DELLA POMPA

Durante l'uso, **non toccare** la pompa con le mani: **pericolo di scottature**. Per l'azionamento della valvola deviatrice usare guanti.



Il Costruttore declina ogni responsabilità per danni causati dalla non osservanza delle norme di installazione e di uso/manutenzione contenute nel presente libretto.



Non superare il regime massimo di rotazione indicato sulla targhetta, vedi pag. 7.



Mantenere il regime di rotazione all'interno del campo indicato in tabella pag. 5.

PRESSIONE

Vedi tabella pag. 5.

TEMPERATURA







La temperatura allo scarico della pompa per vuoto non deve mai superare i 200°C.
In tal caso arrestare la pompa per vuoto per permettere il raffreddamento.

TEMPO MASSIMO UTILIZZO (MINUTI)

Vedi tabella pag. 5.

IMPORTANTE:

Il tempo indicato vale per condizioni normali di funzionamento a impiego discontinuo. Per impieghi gravosi o per uso continuo contattare un rivenditore autorizzato dalla **Allestimenti Pompe Moro S.p.a.**

| ENGLISH | FRANÇAIS | DEUTSCH |
|--|--|---|
| <p style="text-align: center;"><u>MAINTENANCE</u></p> <p>ONLY THE MAINTENANCE JOBS AUTHORIZED IN THIS INSTRUCTIONS MANUAL MAY BE CARRIED OUT BY THE USER. ALL OTHER OPERATIONS ARE FORBIDDEN.</p> <p style="text-align: center;"><u>RUNNING IN</u></p> <p>The first 50 hours of actual operation of the pump are the running-in period. During this period, regularly check the consumption of disposable oil, the discharge temperature and the wear of the vanes. Vane wear should be minimum or negligible. If it is excessive, wear must be checked at regular frequent intervals and the phenomenon should be notified to an authorized dealer. In any case, replace the vanes when wear is 5 mm or more (see page 26).</p> <p> It is forbidden to use a pump with more than 5 mm vane wear. Failure to follow this warning relieves the manufacturer of all responsibility.</p> <p style="text-align: center;"><u>PERIODIC CHECKS</u></p> <p>Periodic checks and maintenance of the machinery are recommended: Several times a day: Check the maximum temperature at discharge. Daily: Check the vacuum and the pressure during operation. Daily: Check the level of the disposable oil. Weekly: Clean the filtering elements of all the filters. Weekly: Check the safety valve. Monthly (or every 100 working hours): Check vane wear.</p> <p>ATTENTION Sealing and sliding surfaces must be free from oil carbon deposits so that the function of the non-return valve is preserved; brief period of free suction is suggested before switching off the pumps.</p> <p> IMPORTANT: The times indicated refer to normal working conditions. For harsh conditions, decrease the intervals for each operation. Keep the pump clean in order to allow better cooling.</p> | <p style="text-align: center;"><u>ENTRETIEN</u></p> <p>L'UTILISATEUR NE PEUT EFFECTUER QUE CE QUI EST PREVU DANS CE MANUEL. TOUTE AUTRE OPERATION EST INTERDITE.</p> <p style="text-align: center;"><u>RODAGE</u></p> <p>Le rodage correspond aux 50 premières heures de fonctionnement effectif de la pompe. Durant cette période, contrôler régulièrement la consommation d'huile du réservoir, la température à la vidange et l'usure des palettes. Cette usure devrait être insignifiante. Si ce n'est pas le cas, contrôler régulièrement l'usure et signaler le phénomène à un revendeur agréé. Changer les palettes quand la consommation est égale ou supérieure à 5 mm (voir page 26).</p> <p> Il est interdit d'utiliser la pompe avec une usure des palettes supérieure à 5 mm. Le constructeur décline toute responsabilité en cas d'inobservation de cette indication.</p> <p style="text-align: center;"><u>CONTROLES PERIODIQUES</u></p> <p>Il est conseillé de contrôler régulièrement l'appareil et d'en assurer l'entretien. Plusieurs fois par jour: Contrôler la température maximum à la vidange. Tous les jours: Contrôler le vide et la pression durant le fonctionnement. Tous les jours: Contrôler le niveau d'huile du réservoir. Toutes les semaines: Nettoyer les éléments filtrants des différents filtres. Toutes les semaines: Contrôler la soupape de sûreté. Tous les mois (ou bien toutes les 100 heures de fonctionnement): Contrôler l'usure des palettes.</p> <p>ATTENTION : pour préserver le correct fonctionnement de la soupape de par retour, les surfaces de tenue et les surfaces de glissement doivent être tenues libres de dépôts carbonés ; on conseille donc, avant l'extinction de la machine, une courte période de fonctionnement en liberté.</p> <p> IMPORTANT: Les temps indiqués se réfèrent aux conditions normales de fonctionnement. En cas d'utilisation difficile, réduire les intervalles de chaque opération. La pompe doit toujours être propre pour qu'elle puisse se refroidir correctement.</p> | <p style="text-align: center;"><u>WARTUNG</u></p> <p>ES DÜRFEN NUR DIE IN DER VORLIEGENDEN BETRIEB-SANLEITUNG AUTORISIERTEN ARBEITEN VOM ANWENDER AUSGEFÜHRT WERDEN. JEDER ANDERE KUNDENSEITIGE EINGRIFF IST VERBOTEN.</p> <p style="text-align: center;"><u>EINLAUFEN</u></p> <p>Die ersten 50 effektiven Betriebsstunden der Pumpe gelten als Einlaufzeit. Während diesem Zeitraum häufig den Verbrauch des Öls, die Temperatur am Auslaß und den Verschleiß der Schaufeln kontrollieren. Der Verschleiß der Schaufeln soll minimal oder nichtig sein. Falls jedoch ein übermäßiger Verschleiß der Schaufeln vorliegen sollte, muß der weitere Verlauf in regelmäßigen Abständen kontrolliert und das Phänomen einem autorisierten Händler gemeldet werden. Bei einem Verschleiß von 5 mm und mehr müssen die Schaufeln in jedem Fall ersetzt werden (siehe Seite 26).</p> <p> Es ist verboten, die Pumpe bei Schaufeln mit einem Verschleiß von mehr als 5 mm zu betreiben. Die Nichtbeachtung dieses Verbots befreit den Hersteller von jeder Haftpflicht.</p> <p style="text-align: center;"><u>REGELMÄSSIGE KONTROLLEN</u></p> <p>Es werden die folgenden regelmäßigen Kontrollen und Inspektionen der Maschine empfohlen:</p> <p>Mehrmals täglich: Die Höchsttemperatur am Auslaß kontrollieren. Täglich: Während der Funktion Vakuum und Druck kontrollieren. Täglich: Den Stand des Verbrauchsöls kontrollieren. Wöchentlich: Die Filterelemente aller Filter reinigen. Wöchentlich: Das Sicherheitsventil kontrollieren. Monatlich (oder alle 100 Betriebsstunden): Den Verschleiß der Schaufeln kontrollieren.</p> <p>ACHTUNG Dicht- und Gleitflächen müssen frei von Ölkohleablagerungen sein, damit die Funktion des Rückschlagventils gewährleistet ist; Vor der Abstellung der Maschine, saugen Sie für Kurze Zeit frei.</p> <p> WICHTIG: Die aufgeführten Intervalle beziehen sich auf normale Betriebsbedingungen. Im Falle von besonders belastenden Betriebsbedingungen müssen die Intervalle der einzelnen Operationen entsprechend verkürzt werden. Halten Sie die Pumpe stets sauber, damit die Kühlung begünstigt wird.</p> |

MANUTENZIONE

**SOLO QUANTO AUTORIZZATO NEL PRESENTE
LIBRETTO ISTRUZIONI PUO' ESSERE ESEGUITO
A CURA DELL' UTILIZZATORE.
QUALSIASI ALTRO INTERVENTO E' VIETATO**

RODAGGIO

Le prime 50 ore di funzionamento effettivo della pompa si intendono di rodaggio. Durante questo periodo controllare con assiduità il consumo di olio a perdere, la temperatura allo scarico e l'usura delle palette. L'usura palette dovrebbe essere minima o irrilevante; nel caso fosse eccessiva è necessario controllare ad intervalli regolari e frequenti l'andamento dell'usura e segnalare il fenomeno contattando un rivenditore autorizzato. In ogni caso sostituire le palette con un consumo eguale o superiore ad 8 mm (vedi pag. 27).



E' vietato usare la pompa con palette usurate più di 8 mm.

La non osservanza di questa indicazione libera il costruttore da ogni responsabilità.

CONTROLLI PERIODICI

Sono raccomandate periodiche supervisioni e manutenzioni del macchinario:

Parecchie volte al giorno:

controllare la temperatura max allo scarico.

Giornalmente:

controllare il vuoto e la pressione durante il funzionamento.

Giornalmente:

controllare il livello dell'olio a perdere.

Settimanalmente:

pulire gli elementi filtranti di tutti i filtri.

Settimanalmente:

controllare la valvola di sicurezza.

Mensilmente (oppure ogni 100 ore di funzionamento):

controllare l'usura delle palette.



ATTENZIONE: al fine di preservare il corretto funzionamento della valvola di non ritorno, le superfici di tenuta e le superfici di scorrimento, devono essere mantenute **esenti da depositi carboniosi**; si consiglia quindi, prima dello spegnimento della macchina, un breve periodo di funzionamento in libera.

**IMPORTANTE:**

I tempi indicati sono per condizioni normali di funzionamento.

Per impieghi gravosi diminuire gli intervalli di ogni operazione.

Mantenere pulita la pompa al fine di permettere il miglior raffreddamento.

| ENGLISH | FRANÇAIS | DEUTSCH |
|--|---|---|
| <p style="text-align: center;"><u>FLUSHING THE INSIDE OF THE PUMP BODY</u></p> <p>1 - Diesel oil 2 - Input pipe 3 - Free air flow 4 - Discharge filter 5 - Drainage cocks</p> <p>1) Switch off the drive system and release the vacuum or pressure from the tank and the suction and discharge system.</p> <p>2) Open the cistern shutters. Prepare the system so as to allow the passage of free air through the vacuum pump in the direction going from the tank to the discharge.</p> <p>3) Fill a container with about 2 kg. or diesel fuel or naphtha.</p> <p>4) With a clamp, connect a rubber hose to the drainage tap upstream from the vacuum pump.</p> <p>5) Immerse the free end of the hose in the container of diesel fuel.</p> <p>6) Start the vacuum pump and check suction of the diesel fuel (about 3-4 min.), repeating the operation of necessary.</p> <p>7) Stop the vacuum pump.</p> <p>8) Remove the rubber hose; drain and clean the pipes and the discharge filter.</p> <p> Collect the diesel oil residue and any sludge and dispose of it suitable.</p> <p>9) When starting next time, follow the same procedure as for the first starting, see page 19, and with additional lubrication, see page 15.</p> | <p style="text-align: center;"><u>LAVAGE DE L'INTERIEUR DU CORPS DE LA POMPE</u></p> <p>1 - Gas-oil 2 - Tube d'adduction 3 - Flux d'air libre 4 - Filtre de vidange 5 - Drainages</p> <p>1) Eteindre l'installation et évacuer le vide et la pression de la citerne et du système d'aspiration et de vidange.</p> <p>2) Ouvrir les vannes de la citerne. L'installation doit être prévue pour permettre à l'air libre qui passe à travers la pompe à vide de circuler de la citerne à la vidange.</p> <p>3) Verser environ 2 Kg de gas-oil ou de mazout dans un récipient.</p> <p>4) A l'aide d'un collier, fixer un tuyau en caoutchouc au robinet de drainage en amont de la pompe à vide.</p> <p>5) Plonger l'extrémité libre du tuyau dans le récipient contenant le gas-oil.</p> <p>6) Amorcer la pompe à vide et contrôler l'aspiration du gas-oil (environ 3,4 min.). Répéter l'opération si nécessaire.</p> <p>7) Arrêter la pompe à vide.</p> <p>8) Enlever le tuyau en caoutchouc, drainer et nettoyer les conduites et le filtre de vidange.</p> <p> Nettoyer les résidus de gas-oil et les dépôts éventuels et les recycler conformément aux réglementations en vigueur.</p> <p>9) Beim folgenden Anlassen das Verfahren für das erste Anlassen befolgen (siehe Seite 19) und die Zusatzschmierung anwenden (siehe Seite 15).</p> | <p style="text-align: center;"><u>INNERE WÄSCHE DES PUMPENKÖRPERS</u></p> <p>1 - Gasöl. 2 - Zuführungsleitung. 3 - Freier Luftstrom. 4 - Auslauffilter. 5 - Dränungen.</p> <p>1) Die Antriebsanlage ausschalten und den Kessel, sowie die Saug- und Auslaßanlage von Vakuum beziehungsweise Druck befreien.</p> <p>2) Den Schieber des Kessels öffnen. Die Anlage so prädisponieren, daß der freie Luftstrom durch die Vakuumpumpe in Richtung vom Kessel zum Auslaß ermöglicht wird.</p> <p>3) Einen Behälter mit zirka 2 kg Gasöl oder Naphta füllen.</p> <p>4) Einen Gummischlauch mit einer Rohrschelle an dem der Vakuumpumpe vorgeschalteten Dränungshahn befestigen.</p> <p>5) Das freie Ende des Schlauchs in den Gasölbehälter tauchen.</p> <p>6) Die Vakuumpumpe einschalten und das Saugen des Gasöls (zirka 3,4 min.) kontrollieren. Diesen Vorgang eventuell wiederholen.</p> <p>7) Die Vakuumpumpe ausschalten.</p> <p>8) Den Gummischlauch entfernen; die Leitungen und den Auslaßfilter dränieren und reinigen.</p> <p> Die Gasölreste und den eventuellen Schlamm aufnehmen und vorschriftsmäßig entsorgen.</p> <p>9) Beim folgenden Anlassen das Verfahren für das erste Anlassen befolgen (siehe Seite 19) und die Zusatzschmierung anwenden (siehe Seite 15).</p> |

LAVAGGIO INTERNO CORPO POMPA

- 1 - Gasolio.
- 2 - Tubo adduzione.
- 3 - Flusso d' aria libera.
- 4 - Filtro di scarico.
- 5 - Drenaggi.

1) Spegnere l'impianto di azionamento e liberare la cisterna e l'impianto di aspirazione e scarico dal vuoto o dalla pressione.

2) Aprire le saracinesche della cisterna.
Predisporre l'impianto in modo da consentire il passaggio di aria libera attraverso la pompa per vuoto nel senso che va dalla cisterna allo scarico.

3) Riempire un contenitore con circa 2 kg di gasolio o nafta.

4) Collegare con una fascetta un tubo di gomma al rubinetto di drenaggio a monte della pompa per vuoto.

5) Immergere l'estremità libera del tubo nel contenitore di gasolio.

6) Avviare la pompa per vuoto e controllare l'aspirazione del gasolio (circa 3÷4 min) eventualmente ripetere l'operazione.

7) Fermare la pompa per vuoto.







8) Rimuovere il tubo di gomma; drenare e pulire le tubazioni e il filtro di scarico.

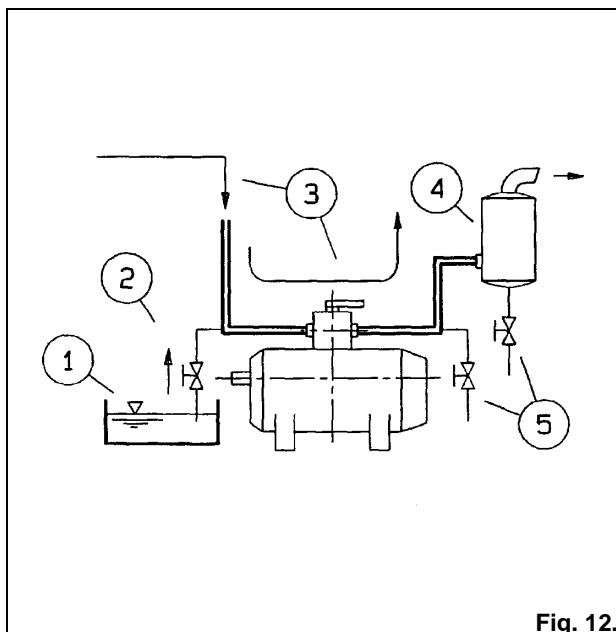

Raccogliere e smaltire opportunamente i residui di gasolio e le eventuali morchie.

9) Al successivo riavvio procedere con la procedura di primo avvio (vedi pag. 19) e con la lubrificazione addizionale (vedi pag. 15).



| ENGLISH | FRANÇAIS | DEUTSCH |
|---|---|--|
| <p style="text-align: center;"><u>CHECKING VANE WEAR</u></p> <p>It is possible to check the wear of the rotor vanes without dismantling the pump:</p> <ul style="list-style-type: none"> • Remove the hexagonal socket cap, fig. 11, page 19. • Insert a rod (diameter 6 mm, length 100 mm) in the hole as in figure 13. • Turn the rotor shaft by hand until the rod touches the external diameter of the rotor, figure 13. • With a marking awl, mark the rod at the position of the threaded hole, figure 13. • Turn the rotor again until the rod enters one of the slots in the vanes, figure 14. • Mark the rod with the awl again and measure the difference between the two measurements, figure 14. • The maximum difference may be 5 mm. If it is any larger, all the vanes must be replaced immediately. <p> If all the vanes have to be replaced, apply to an authorized service centre.</p> <p>Working with a worn vane may cause serious damage to the vacuum pump.</p> <p>Failure to follow this warning relieves the manufacturer of all responsibility.</p> <p>After measuring, screw the cap on again with sealing paste or Teflon.</p> <p>ATTENTION: When the cap is not fitted, the flow rate and vacuum are reduced.</p> <p> Insist on original Allestimenti Pompe Moro S.p.a. spare parts.</p> <p>IMPORTANT: For maintenance and/or repairs, use only original spare parts which offer greater quality, reliability and safety. Failure to use original spare parts relieves the manufacturer of all responsibility.</p> | <p style="text-align: center;"><u>CONTROLE DE L'USURE DES PALETTES</u></p> <p>Le contrôle de l'usure des palettes du rotor peut être effectué sans démonter la pompe. Procéder comme suit:</p> <ul style="list-style-type: none"> • Enlever le bouchon hexagonal encastré (Fig. 11 page 19). • Introduire une baguette ronde (diamètre 6 mm, longueur 100 mm) dans le trou Fig. 13. • Tourner à la main l'arbre du rotor pour que la baguette touche le diamètre externe du rotor (Fig. 13). • Avec un outil pointu, faire une marque sur la baguette à la hauteur du trou fileté (Fig. 13). • Tourner encore le rotor pour que la baguette entre dans une fissure des palettes (Fig. 14). • Avec l'outil pointu, faire à nouveau une marque sur la baguette et mesurer la différences entre les deux marques (Fig. 14). • Cette différence doit être au maximum de 5 mm. Si elle est supérieure, il faut changer immédiatement toutes les palettes. <p> Pour changer les palettes, s'adresser à un service après-vente agréé.</p> <p>Opérer avec des palettes usées peut endommager sérieusement la pompe.</p> <p>Le constructeur décline toute responsabilité en cas d'inobservation de cette indication.</p> <p>Après avoir effectué cette opération, revisser le bouchon en utilisant de la pâte freine-filet ou du Téflon.</p> <p>ATTENTION: Sans le bouchon, la portée et le vide sont réduits.</p> <p> N'utiliser que des pièces détachées d'origine.</p> <p>IMPORTANT: Pour l'entretien et/ ou les réparations, n'utiliser que des pièces détachées d'origine offrant toutes les caractéristiques de qualité, fiabilité et sécurité. Le constructeur décline toute responsabilité en cas d'utilisation de pièces détachées non d'origine.</p> | <p style="text-align: center;"><u>KONTROLLE DES SCHAUFELVERSCHLEISSES</u></p> <p>Der Verschleißzustand der Läuferschaufeln kann ohne Auseinandernehmen der Pumpe kontrolliert werden:</p> <ul style="list-style-type: none"> • Den versenkten Sechskantdeckel (Abb.11, Seite 19) abnehmen. • Einen Rundstab (Durchmesser 6 mm, Länge 100 mm) in das Loch stecken (Abb.13). • Die Motorwelle von Hand drehen, bis der Rundstab den Außendurchmesser des Läufers berührt (Abb.13). • Mit einer Anreißnadel den Rundstab auf Höhe des Gewindelochs markieren (Abb.13). • Nochmals den Läufer drehen, bis der Rundstab in einen Schlitz der Schaufeln eindringt (Abb.14). • Nun erneut den Rundstab markieren und den Unterschied zwischen den beiden Meßwerten feststellen (Abb.14). • Dieser Unterschied darf höchstens 5 mm betragen. Falls der Unterschied größer sein sollte, müssen umgehend alle Schaufeln ersetzt werden. <p> Falls die Schaufeln ausgewechselt werden müssen, wenden Sie sich am besten an eine Vertragswerkstätte.</p> <p>Der Betrieb mit verschlissenen Schaufeln kann die Vakuumpumpe schwerwiegend beschä-digen. Die Nichtbeachtung dieses Hinweises befreit den Hersteller von jeder Haftungspflicht.</p> <p>Nach dem Meßvorgang den Deckel wieder mit Hilfe von Dichtmasse oder Teflon einschrauben.</p> <p>ACHTUNG: bei fehlendem Deckel wird die Förderleistung und Vakuumherzeugung verringert.</p> <p> Verlangen Sie stets Original-Ersatzteile von Allestimenti Pompe Moro S.p.a.</p> <p>WICHTIG: Verwenden Sie für Wartungs- und/oder Reparaturarbeiten ausschließlich Original-Ersatzteile, welche die besten Merkmale hinsichtlich Qualität, Zuverlässigkeit und Sicherheit bieten. Die mangelnde Verwendung von Original-Ersatzteilen enthebt den Hersteller von jeder Verantwortung.</p> |

CONTROLLO USURA PALETTE

E' possibile controllare l'usura delle palette del rotore senza smontare la pompa:

- Rimuovere il tappo ad esagono incassato fig. 11 pag. 19.
- Inserire nel foro un tondino (diametro 6 mm. lunghezza 100 mm) figura 13.
- Girare l'albero del rotore a mano finchè il tondino tocchi sul diametro esterno del rotore figura 13.
- Con una punta a tracciare segnare il tondino all'altezza del foro filettato figura 13.
- Girare ancora il rotore finchè il tondino entra in una feritoia delle palette figura 14.
- Con la punta segnare di nuovo il tondino e misurare la differenza tra le due misure figura 14.
- La differenza può essere al massimo di 5 mm. Se la differenza è maggiore occorre sostituire immediatamente tutte le palette.



Nel caso si presenti la necessità di sostituire le palette rivolgersi ad un officina autorizzata.

Operare con palette usurate può danneggiare seriamente la pompa per vuoto.

La non osservanza di questa indicazione libera il costruttore da ogni responsabilità.

Dopo la misurazione avvitarne nuovamente il tappo con pasta sigillante o teflon.

ATTENZIONE: Senza il tappo la portata e il vuoto vengono ridotti.



Richiedere ricambi originali **Allestimenti Pompe Moro S.p.a.**

IMPORTANTE:

Per la manutenzione e/o riparazione utilizzare solo ricambi originali che offrono le maggiori caratteristiche di qualità, affidabilità e sicurezza.

Il mancato uso di ricambi originali libera il costruttore da ogni responsabilità.

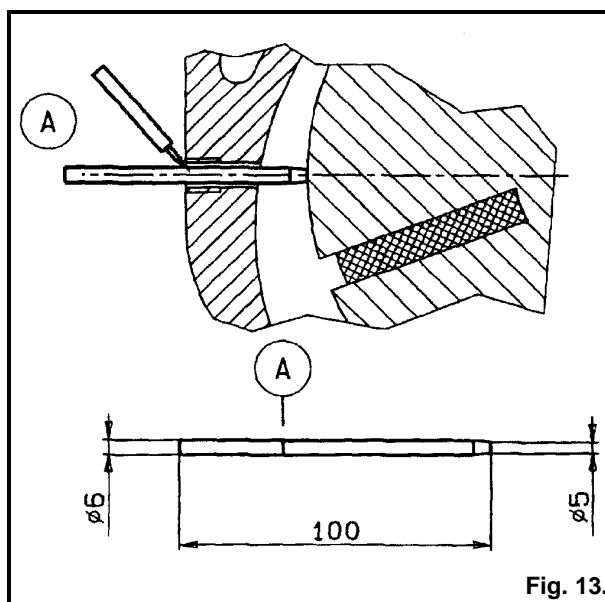

Fig. 13.

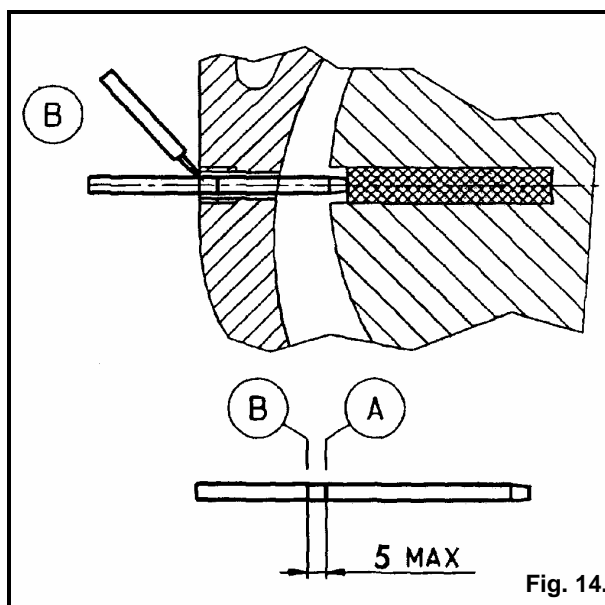

Fig. 14.

TROUBLESHOOTING

| FAULT | CAUSES | REMEDIES |
|---|---|---|
| Reduced vacuum. | Leakage or partial obstruction in the system components. The vanes are stuck in their seat. No lubrication. | Check the valves and elements in the system. Flush the vacuum pump with diesel fuel (see page 25). Check the level of the disposable oil and dripping of the oiler. |
| Inverse rotation of the vacuum pump, with vacuum in the tank. | Non-return valve not hermetically sealed. | Apply to an authorized service centre. |
| Excessive continuous knocking noise. | Excessive vane wear. No lubrication. The vanes are stuck in their seat. Rev speed too low. | Change the vanes. Apply to an authorized service centre. Check the level of the disposable oil. Flush the vacuum pump with diesel fuel (see page 25). Increase the number of revs to above 1100 rpm. |
| Overheating of the vacuum pump. | Operation conditions too harsh or continuous. | Let the pump cool. Apply to an authorized service centre. |
| The pump does not reach rated pressure, or gets stuck. | Suction of liquids, mud or foreign bodies. | Flush the vacuum pump with diesel fuel (see page 25). |
| Excessive consumption of disposable oil. | Use gaskets. | Apply to an authorized service centre. |



If the fault persists, apply to an authorized service centre.



REMOVING FROM SERVICE AND SCRAPPING

Before demolition of the vacuum pump, the following materials must be separated:

- lubricating oil;
- rubber and plastic parts;
- cast iron, steel and aluminium parts;

these must be disposed of appropriately.

- Do not dump the vacuum pump in the environment.
- To dispose of lubricating oil, apply to the special treatment services.

Do not use parts dismantled as scrap for spare parts.

Failure to follow this warning relieves the manufacturer of all responsibility and constitutes negligent use of the product.

MAUVAIS FONCTIONNEMENT: CAUSES ET REMEDES

| PROBLEMES | CAUSES | REMEDES |
|---|--|---|
| Diminution du degré de vide. | Fuites ou obstruction partielle dans les composants de l'installation. Les palettes sont collées dans leur logement. Il manque de l'huile. | Contrôler les soupapes et les éléments de l'installation. Laver la pompe à vide avec du gas-oil (voir page 25). Contrôler le niveau d'huile du réservoir et l'écoulement du graisseur. |
| Rotation inverse de la pompe à vide, avec vide dans la citerne. | La soupape de non retour n'est pas étanche. | S'adresser à un Service après-vente agréé. |
| Bruit excessif de martèlement continu. | Usure excessive des palettes. Il manque de l'huile. Les palettes sont collées dans leur logement. Nombre de tours trop bas. | Changer les palettes. S'adresser à un Service après-vente agréé. Contrôler le niveau d'huile du réservoir. Laver la pompe à vide avec du gas-oil (voir page 25). Augmenter le nombre de tours au delà de 1100 r.p.m. |
| Surchauffe de la pompe à vide. | Fonctionnement continu ou en conditions difficiles. | Laisser refroidir. S'adresser à un Service après-vente autorisé. |
| La pompe n'atteint pas les performances nominales ou se bloque. | Aspiration de liquides, de boue ou de corps étrangers. | Laver la pompe avec du gas-oil (voir page 25). |
| Consommation excessive de l'huile du réservoir. | Usure des joints. | S'adresser à un Service après-vente. |



Si l'anomalie subsiste, s'adresser à un Service après-vente agréé.

**DEMOLITION**

Avant de démolir la pompe à vide il faut séparer les matériaux suivants:

- huile de graissage,
- parties en caoutchouc et en plastique,
- parties en fonte, en acier et en aluminium
- et les recycler de façon appropriée.
- Ne pas abandonner la pompe à vide n'importe où.
- Pour le recyclage de l'huile de graissage, s'adresser à un Centre spécialisé.

Ne pas utiliser les pièces à recycler comme pièces détachées.

Le constructeur décline toute responsabilité en cas d'observation de cette indication.

FUNKTIONSTÖRUNGEN: URSACHEN UND ABHILFEN

| PROBLEME | URSACHEN | ABHILFEN |
|--|--|---|
| Verminderung des Vakuumgrades | Verlust oder teilweise Verstopfung an den Anlagenkomponenten. Verkleben der Schaufeln in ihrem Sitz. Mangelnde Schmierung. | Ventile und Elemente der Anlage kontrollieren. Die Vakuumpumpe mit Gasöl waschen (siehe Seite 25). Den Stand des Verbrauchsöls und das Tropfen des Ölers kontrollieren. |
| Umgekehrte Drehrichtung der Vakuumpumpe, bei Vakuum im Kessel. | Mangelnde Dichtigkeit des Rückschlagventils. | Ein autorisiertes Kundendienst-Zentrum hinzuziehen. |
| Übermäßiges ständiges Klopfen | Übermäßiger Verschleiß der Schaufeln. Mangelnde Schmierung. Verkleben der Schaufeln in ihrem Sitz Zu niedrige Drehzahl. | Schaufeln auswechseln. Ein autorisiertes Kundendienst-Zentrum hinzuziehen. Den Stand des Verbrauchsöls. Die Vakuumpumpe mit Gasöl waschen (siehe Seite 25). Drehzahl auf über 1100 U/min bringen. |
| Heißlaufen der Vakuumpumpe. | Funktion unter zu belastenden Bedingungen oder Dauerbetrieb. | Abkühlen lassen. Ein autorisiertes Kundendienst-Zentrum hinzuziehen. |
| Die Pumpe erreicht die Nennleistungen nicht oder blockiert sich. | Ansaugen von Flüssigkeiten, Schlamm oder Fremdkörpern. | Die Vakuumpumpe mit Gasöl waschen (siehe Seite 25). |
| Übermäßiger Ölverbrauch. | Verschleiß der Dichtungen. | Ein autorisiertes Kundendienst-Zentrum hinzuziehen. |



Falls die Störung nicht beseitigt werden kann, ein autorisiertes Kundendienst-Zentrum hinzuziehen.

**AUSRANGIEREN UND VERSCHROTEN**

Vor dem Verschrotten der Vakuumpumpe müssen die folgenden Materialien getrennt sortiert werden:

- Schmieröl;
- Teile aus Gummi- und Plastik;
- Teile aus Guß, Stahl und Aluminium;

- die vorschriftsmäßig entsorgt werden müssen.
- Die Vakkumpumpe nicht unkontrolliert wegwerfen.
- Die Schmieröle müssen durch Spezialunternehmen entsorgt werden.

**Ausgebaute, zu verschrottende Teile nicht als Ersatzteile verwenden.
Die Nichtbefolgung dieser Vorschriften enthebt den Hersteller von jeder Verantwortung und stellt einen fahrlässigen Gebrauch dar.**

CAUSE E RIMEDI DI UN CATTIVO FUNZIONAMENTO

| PROBLEMI | CAUSE | RIMEDI |
|---|---|---|
| Diminuzione del grado di vuoto | Perdite o parziale ostruzione nei componenti del impianto. Incollaggio delle palette nella propria sede. Mancanza di lubrificazione | Verificare le valvole e gli elementi dell' impianto. Lavare la pompa per vuoto con gasolio (vedi pag.25). Verificare il livello dell'olio a perdere. |
| Rotazione inversa della pompa per vuoto, con vuoto in cisterna. | Mancanza tenuta valvola di non ritorno. | Rivolgersi ad un Centro assistenza autorizzato. |
| Eccessivo rumore di martellamento continuato. | Eccessiva usura delle palette. Mancanza di lubrificazione. Incollaggio delle palette nella loro sede. Numero di giri troppo basso. | Sostituire le palette. Rivolgersi ad un Centro assistenza autorizzato. Verificare il livello dell'olio a perdere. Lavare la pompa per vuoto con gasolio (vedi pag.25). Incrementare il numero di giri fino a 1100 r.p.m. |
| Surriscaldamento della pompa per vuoto. | Funzionamento eccessivamente gravoso o continuativo. | Lasciare raffreddare. Rivolgersi ad un Centro assistenza autorizzato. |
| La pompa non raggiunge le prestazioni nominali, o si blocca. | Aspirazione liquidi, fango o corpi estranei. | Lavare la pompa per vuoto con gasolio (vedi pag. 25) |
| Eccessivo consumo di olio a perdere. | Usura guarnizioni. | Rivolgersi ad un Centro assistenza autorizzato. |



Al persistere dell'inconveniente rivolgersi ad un centro assistenza autorizzato.

**MESSA FUORI SERVIZIO E ROTTAMAZIONE**

Prima della demolizione della pompa per vuoto è necessario suddividere i seguenti materiali:

- olio di lubrificazione;
- parti in gomma e plastica;
- parti in ghisa, acciaio e alluminio;

- Smaltendoli in maniera appropriata.
- Non abbandonare la pompa per vuoto nell'ambiente.
- Per lo smaltimento dell'olio di lubrificazione utilizzare servizi specializzati di trattamento.

Non utilizzare come pezzi di ricambio le parti smontate da rottamare.

Il non rispetto di quanto sopra previsto, libera il costruttore da ogni responsabilità e rappresenta uso negligente del prodotto.



Via Pontebbana, 16
33080 Fiume Veneto
Pordenone, ITALY
Tel. 0434 / 951211
Fax 0434 / 959464